

BK PRECISION®

Model: 891

300 kHz Bench LCR Meter

USER MANUAL



Safety Summary

The following safety precautions apply to both operating and maintenance personnel and must be followed during all phases of operation, service, and repair of this instrument.



Before applying power to this instrument:

- Read and understand the safety and operational information in this manual.
- Apply all the listed safety precautions.
- Verify that the voltage selector at the line power cord input is set to the correct line voltage. Operating the instrument at an incorrect line voltage will void the warranty.
- Make all connections to the instrument before applying power.
- Do not operate the instrument in ways not specified by this manual or by B&K Precision.

Failure to comply with these precautions or with warnings elsewhere in this manual violates the safety standards of design, manufacture, and intended use of the instrument. B&K Precision assumes no liability for a customer's failure to comply with these requirements.

Category rating

The IEC 61010 standard defines safety category ratings that specify the amount of electrical energy available and the voltage impulses that may occur on electrical conductors associated with these category ratings. The category rating is a Roman numeral of I, II, III, or IV. This rating is also accompanied by a maximum voltage of the circuit to be tested, which defines the voltage impulses expected and required insulation clearances. These categories are:

Category I (CAT I): Measurement instruments whose measurement inputs are not intended to be connected to the mains supply. The voltages in the environment are typically derived from a limited-energy transformer or a

battery.

Category II (CAT II): Measurement instruments whose measurement inputs are meant to be connected to the mains supply at a standard wall outlet or similar sources. Example measurement environments are portable tools and household appliances.

Category III (CAT III): Measurement instruments whose measurement inputs are meant to be connected to the mains installation of a building. Examples are measurements inside a building's circuit breaker panel or the wiring of permanently-installed motors.

Category IV (CAT IV): Measurement instruments whose measurement inputs are meant to be connected to the primary power entering a building or other outdoor wiring.



Do not use this instrument in an electrical environment with a higher category rating than what is specified in this manual for this instrument.



You must ensure that each accessory you use with this instrument has a category rating equal to or higher than the instrument's category rating to maintain the instrument's category rating. Failure to do so will lower the category rating of the measuring system.

Electrical Power

This instrument is intended to be powered from a CATEGORY II mains power environment. The mains power should be 115 V RMS or 230 V RMS. Use only the power cord supplied with the instrument and ensure it is appropriate for your country of use.

Ground the Instrument

! WARNING

To minimize shock hazard, the instrument chassis and cabinet must be connected to an electrical safety ground. This instrument is grounded through the ground conductor of the supplied, three-conductor AC line power cable. The power cable must be plugged into an approved three-conductor electrical outlet. The power jack and mating plug of the power cable meet IEC safety standards.

! WARNING

Do not alter or defeat the ground connection. Without the safety ground connection, all accessible conductive parts (including control knobs) may provide an electric shock. Failure to use a properly-grounded approved outlet and the recommended three-conductor AC line power cable may result in injury or death.

! WARNING

Unless otherwise stated, a ground connection on the instrument's front or rear panel is for a reference of potential only and is not to be used as a safety ground.

Do not operate in an explosive or flammable atmosphere

! WARNING

Do not operate the instrument in the presence of flammable gases or vapors, fumes, or finely-divided particulates.

WARNING

The instrument is designed to be used in office-type indoor environments. Do not operate the instrument

- In the presence of noxious, corrosive, or flammable fumes, gases, vapors, chemicals, or finely-divided particulates.
- In relative humidity conditions outside the instrument's specifications.
- In environments where there is a danger of any liquid being spilled on the instrument or where any liquid can condense on the instrument.
- In air temperatures exceeding the specified operating temperatures.
- In atmospheric pressures outside the specified altitude limits or where the surrounding gas is not air.
- In environments with restricted cooling air flow, even if the air temperatures are within specifications.
- In direct sunlight.

CAUTION

This instrument is intended to be used in an indoor pollution degree 2 environment. The operating temperature range is 0 °C to 40 °C and 20% to 80% relative humidity, with no condensation allowed.

Measurements made by this instrument may be outside specifications if the instrument is used in non-office-type environments. Such environments may include rapid temperature or humidity changes, sunlight, vibration and/or mechanical shocks, acoustic noise, electrical noise, strong electric fields, or strong magnetic fields.

Do not operate instrument if damaged

WARNING

If the instrument is damaged, appears to be damaged, or if any liquid, chemical, or other material gets on or inside the instrument, remove the instrument's power cord, remove the instrument from service, label it as not to be operated, and return the instrument to B&K Precision for repair. Notify B&K Precision of the nature of any contamination of the instrument.

Clean the instrument only as instructed

 WARNING

Do not clean the instrument, its switches, or its terminals with contact cleaners, abrasives, lubricants, solvents, acids/bases, or other such chemicals. Clean the instrument only with a clean dry lint-free cloth or as instructed in this manual.

Not for critical applications

 WARNING

This instrument is not authorized for use in contact with the human body or for use as a component in a life-support device or system.

Do not touch live circuits

 WARNING

Instrument covers must not be removed by operating personnel. Component replacement and internal adjustments must be made by qualified service-trained maintenance personnel who are aware of the hazards involved when the instrument's covers and shields are removed. Under certain conditions, even with the power cord removed, dangerous voltages may exist when the covers are removed. To avoid injuries, always disconnect the power cord from

the instrument, disconnect all other connections (for example, test leads, computer interface cables, etc.), discharge all circuits, and verify there are no hazardous voltages present on any conductors by measurements with a properly-operating voltage-sensing device before touching any internal parts. Verify the voltage-sensing device is working properly before and after making the measurements by testing with known-operating voltage sources and test for both DC and AC voltages. Do not attempt any service or adjustment unless another person capable of rendering first aid and resuscitation is present. Do not insert any object into an instrument's ventilation openings or other openings.

WARNING

Hazardous voltages may be present in unexpected locations in circuitry being tested when a fault condition in the circuit exists.

Fuse replacement

WARNING

Fuse replacement must be done by qualified service-trained maintenance personnel who are aware of the instrument's fuse requirements and safe replacement procedures. Disconnect the instrument from the power line before replacing fuses. Replace fuses only with new fuses of the fuse types, voltage ratings, and current ratings specified in this manual or on the back of the instrument. Failure to do so may damage the instrument, lead to a safety hazard, or cause a fire. Failure to use the specified fuses will void the warranty.

Servicing

CAUTION

Do not substitute parts that are not approved by B&K Precision or modify this instrument. Return the instrument to B&K Precision for service and repair to

ensure that safety and performance features are maintained.

Cooling fans



This instrument contains one or more cooling fans. For continued safe operation of the instrument, the air inlet and exhaust openings for these fans must not be blocked nor must accumulated dust or other debris be allowed to reduce air flow. Maintain at least 25 mm clearance around the sides of the instrument that contain air inlet and exhaust ports. If mounted in a rack, position power devices in the rack above the instrument to minimize instrument heating while rack mounted. Do not continue to operate the instrument if you cannot verify the fan is operating (note some fans may have intermittent duty cycles). Do not insert any object into the fan's inlet or outlet.

For continued safe use of the instrument

- Do not place heavy objects on the instrument.
- Do not obstruct cooling air flow to the instrument.
- Do not place a hot soldering iron on the instrument.
- Do not pull the instrument with the power cord, connected probe, or connected test lead.
- Do not move the instrument when a probe is connected to a circuit being tested.

Compliance Statements

Disposal of Old Electrical & Electronic Equipment (Applicable in the European Union and other European countries with separate collection systems)

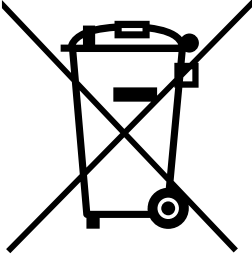

This product is subject to Directive 2002/96/EC of the European Parliament and the Council of the European Union on waste electrical and electronic equipment (WEEE), and in jurisdictions adopting that Directive, is marked as being put on the market after August 13, 2005, and should not be disposed of as unsorted municipal waste. Please utilize your local WEEE collection facilities in the disposition of this product and otherwise observe all applicable requirements.

CE Declaration of Conformity

This instrument meets the requirements of 2006/95/EC Low Voltage Directive and 2004/108/EC Electromagnetic Compatibility Directive with the following standards.

Low Voltage Directive

- EN61010-1: 2001

EMC Directive

- EN 61000-3-2: 2006
- EN 61000-3-3: 1995+A1: 2001+A2: 2005
- EN 61000-4-2 / -3 / -4 / -5 / -6 / -11
- EN 61326-1: 2006

Safety Symbols











	<p>Refer to the user manual for warning information to avoid hazard or personal injury and prevent damage to instrument.</p>
	<p>Electric Shock hazard</p>
	<p>Alternating current (AC)</p>
	<p>Chassis (earth ground) symbol.</p>
	<p>Ground terminal</p>
	<p>On (Power). This is the In position of the power switch when instrument is ON.</p>
	<p>Off (Power). This is the Out position of the power switch when instrument is OFF.</p>
	<p>CAUTION indicates a hazardous situation which, if not avoided, will result in minor or moderate injury</p>
	<p>WARNING indicates a hazardous situation which, if not avoided, could result in death or serious injury</p>
	<p>DANGER indicates a hazardous situation which, if not avoided, will result in death or serious injury.</p>
	<p>NOTICE is used to address practices not related to physical injury.</p>

Table of Contents

Safety Summary	i
Compliance Statements	viii
Safety Symbols	x
1 General Information.....	1
1.1 Product Overview	1
1.2 Package Contents	1
1.3 Front Panel Overview	3
<i>Front Panel Description</i>	<i>3</i>
1.4 Keypad Overview.....	4
<i>Main Keypad Description.....</i>	<i>4</i>
<i>Menu Keypad Description.....</i>	<i>5</i>
1.5 Rear Panel Overview	6
<i>Rear Panel Description</i>	<i>6</i>
1.6 Display Overview	7
<i>Display Description</i>	<i>7</i>
2 Getting Started	8
2.1 Input Power Requirements	8
<i>Input Power</i>	<i>8</i>
<i>Fuse Requirements</i>	<i>9</i>
<i>Fuse Replacement.....</i>	<i>9</i>
2.2 Preliminary Check.....	10
3 Making Measurements	11
3.1 Open and Short Calibration.....	11
<i>Open Calibration.....</i>	<i>11</i>

	<i>Short Calibration</i>	11
3.2	Parameter Entry	12
3.3	Impedance Parameters	14
	<i>Series and Parallel Models</i>	16
	<i>Choosing a Test Frequency</i>	17
	<i>Choosing a Measurement Circuit Model</i>	18
3.4	Configure Basic Measurement	21
	<i>Primary Parameters</i>	21
	<i>Secondary Parameters</i>	22
	<i>Parameter Combinations</i>	23
	<i>Measurement Options</i>	23
	<i>Measurement Display</i>	24
3.5	Bin Sorting Function	26
	<i>Absolute Mode</i>	27
	<i>Tolerance Mode</i>	28
	<i>Bin Display</i>	30
	<i>Table Display</i>	30
	<i>Histogram Display</i>	31
	<i>Configure Bin Function</i>	32
3.6	Sweep Function	35
	<i>Linear Sweep Mode</i>	35
	<i>Logarithmic Sweep Mode</i>	36
	<i>Table Display</i>	36
	<i>Configure Sweep Function</i>	37
	<i>AUTOSCALE</i>	39
	<i>AUTOFREQ</i>	39
	<i>INTERP</i>	39

4	System	43
	<i>System Information</i>	<i>44</i>
	<i>System Setup</i>	<i>46</i>
	<i>Communication Setup</i>	<i>48</i>
5	Save/Recall	49
	<i>Save/Recall a Measurement Configuration.....</i>	<i>51</i>
	<i>Save a Measurement Result</i>	<i>54</i>
	<i>Save a Screenshot.....</i>	<i>57</i>
6	Remote Interface	59
6.1	Interface Configuration	59
	<i>USB (Virtual COM)</i>	<i>59</i>
	<i>GPIB.....</i>	<i>60</i>
	<i>LAN (Ethernet).....</i>	<i>60</i>
6.2	Parameter Definition	65
6.3	Error/Event List.....	66
6.4	SCPI Common Commands	67
6.5	SCPI Command Subsystem	67
7	Troubleshooting Guide	75
8	Specifications.....	76
	<i>Basic Measurement Function</i>	<i>76</i>
	<i>Measurement Accuracy.....</i>	<i>78</i>
	SERVICE INFORMATION	84
	LIMITED THREE-YEAR WARRANTY	85

1 General Information

1.1 Product Overview

The B&K Precision model 891 bench LCR meter is a high accuracy component tester that is capable of testing inductors, capacitors and resistors with adjustable test frequency from 20 Hz to 300 kHz. The 891 has a 2U half rack form factor and is suitable for standard rack mount installation. With the vivid 4.3-inch color graphic LCD, users can operate and read the measurements easily.

Integrated BIN comparator function enables model 891 Bench LCR Meter to quickly sort components up to 10 bins. The easy to operate sweep function provides a quick look of the component characteristics over any range of test frequencies. With built-in USB, GPIB and Ethernet interfaces, the 891 can be remotely controlled to perform daily operations in production, quality control and laboratory environments.

Features:

- Best accuracy 0.05%
- Test frequency from 20 Hz to 300 kHz
- Frequency sweep function
- Bin sorting comparator
- Adjustable measurement speed for fast readout or better accuracy
- Standard USB, GPIB and Ethernet interface
- Save and recall up to 10 internal/90 external measurement setups
- 4.3" color TFT LCD with 480 x 272 pixels

1.2 Package Contents

Please inspect the instrument mechanically and electrically upon receiving it. Unpack all items from the shipping carton, and check for any obvious signs of physical damage that may have occurred during transportation. Report any damage to the shipping agent immediately. Save the original packing carton for possible future reshipment. Every instrument is shipped with the

following contents:

- **1 x Model 891 bench LCR meter**
- **1 x User Manual**
- **1 x AC power cord**
- **1 x 4-wire Kelvin clip test lead**
- **1 x Certificate of calibration**
- **1 x Test report**

Verify that all items above are included in the shipping container. If anything is missing, please contact B&K Precision.

1.3 Front Panel Overview

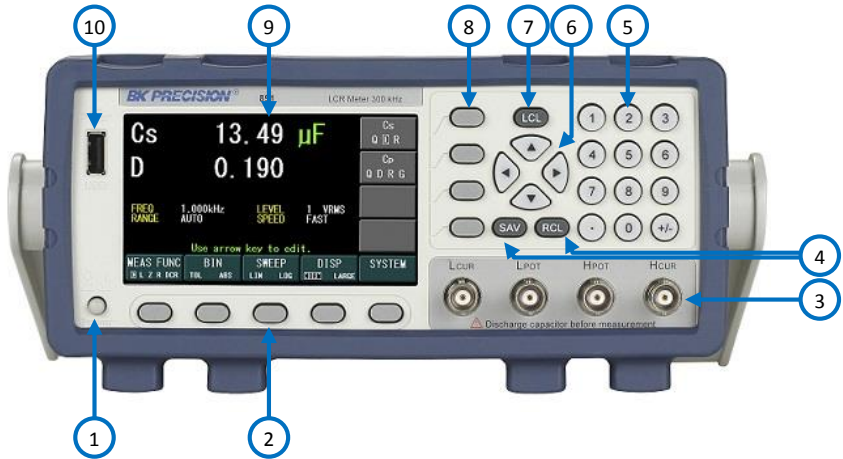

Figure 1.1 – Front Panel Overview

Front Panel Description

①	Power On/Off Switch
②	Menu Keys
③	Measurement Terminal
④	Save/Recall Keys
⑤	Numeric Keypad
⑥	Arrow Keys
⑦	Local Key
⑧	Softkeys
⑨	4.3" TFT Color LCD Display Window
⑩	USB Host Port

1.4 Keypad Overview

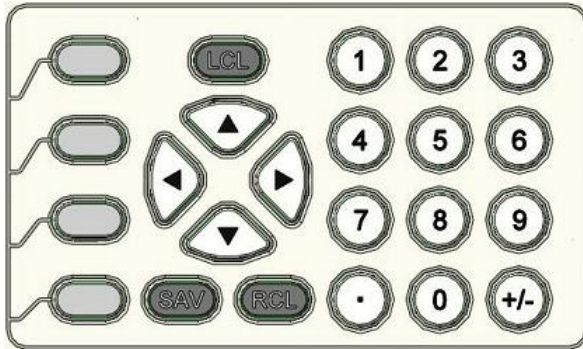

Figure 1.2 – Main Keypad Overview

Main Keypad Description









	Local: Switch to local operation
	Recall: Recall the configuration from internal memory or external USB flash.
	Save: Save the configuration, screen and result to internal memory or external USB flash.
	Up: Moves the cursor up
	Down: Moves the cursor down
	Left: Moves the cursor left
	Right: Moves the cursor right
	Decimal: Decimal point during numeric entry
	Sign: Plus or minus sign during a numeric entry



Figure 1.3 - Menu Keypad Overview

Menu Keypad Description

MEAS FUNC	<i>Measurement function selection of C, L, Z, R and DCR</i>
BIN	<i>Bin comparator measurement of tolerance mode and absolute mode</i>
SWEEP	<i>Frequency sweep measurement</i>
DISP	<i>Display option configuration</i>
SYSTEM	<i>System settings menu</i>

1.5 Rear Panel Overview

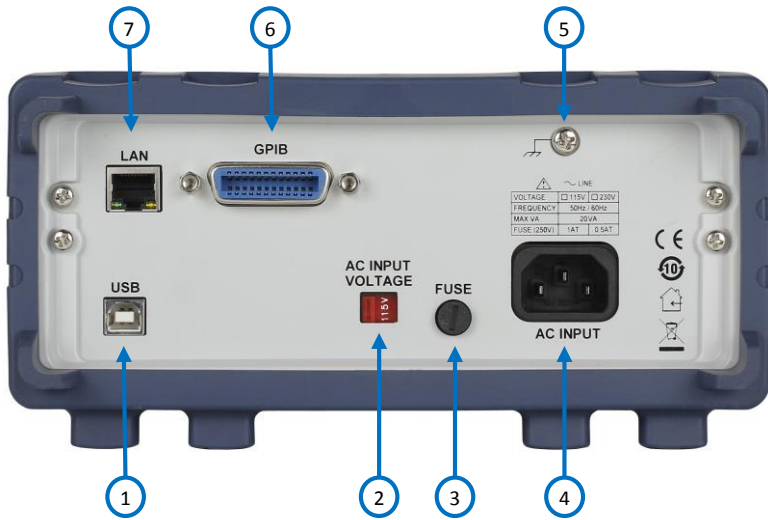

Figure 1.4 - Rear Panel Overview

Rear Panel Description

① Power On/Off Switch

② Menu Keys

③ Measurement Terminal

④ Save/Recall Keys

⑤ Numeric Keypad

⑥ Arrow Keys

⑦ Local Key

1.6 Display Overview

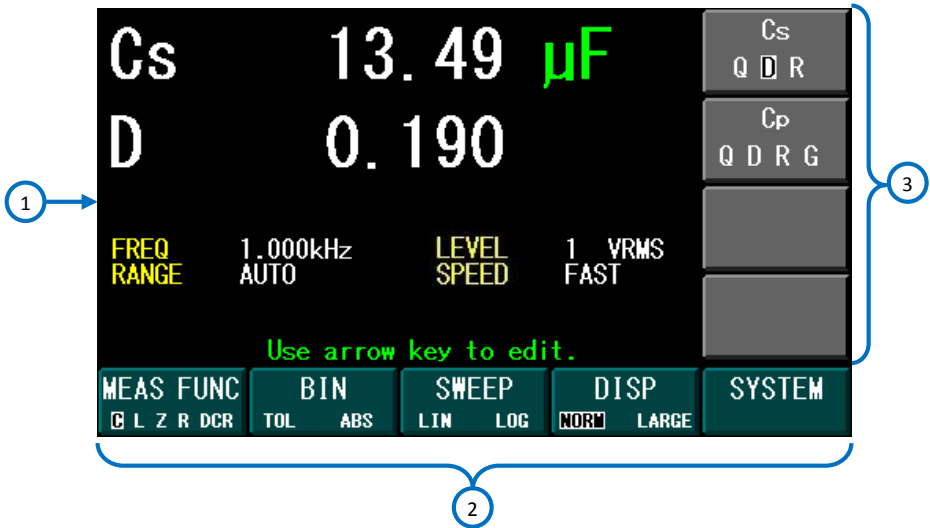

Figure 1.5 – Display Overview

Display Description

①	Main Display Area <i>Displays measurement conditions and measurement results corresponding to the measurement modes.</i>
②	Menu Functions <i>Displays the current measurement mode.</i>
③	Menu Options <i>Displays label options corresponding to the active field.</i>

2 Getting Started

Before connecting and powering up the instrument, please review and go through the instructions in this chapter.

2.1 Input Power Requirements

Input Power

The instrument has a selectable AC input that accepts line voltage and frequency input within:

AC Input: **104 – 126 V / 207 – 253 V (selectable)**

Frequency: **47 – 63 Hz**

Before connecting to an AC outlet or external power source, be sure that the voltage selection switch is at the correct position of 115 V or 230 V and the power switch is in the OFF position. Also, verify that the AC power cord, including the extension line, is compatible with the rated voltage/current and that there is sufficient circuit capacity for the power supply. Once verified, connect the cable firmly.

WARNING

The included AC power cord is safety certified for this instrument operating in rated range. To change a cable or add an extension cable, be sure that it can meet the required power ratings for this instrument. Any misuse with wrong or unsafe cables will void the warranty.

Fuse Requirements

An AC input fuse is necessary when powering the instrument. The fuse is located at the back of the instrument. In the event the fuse needs to be replaced, make sure the AC input power cord is disconnected from the instrument before replacing. Refer to the table below for the fuse requirements with either 115 VAC or 230 VAC.

WARNING



Before replacing fuse, disconnect AC input power cord first to prevent electric shock.

Only use same rating of the fuse. Using a different rated fuse may damage the instrument.

Table 2.1 – Fuse Requirements

Model	Fuse Specification (115 V)	Fuse Specification (230 V)
891	T 1 A, 250 V	T 500 mA, 250 V

Fuse Replacement

Follow the steps below to replace or check the fuse.

1. Locate the fuse box in the rear panel of the instrument, next to the AC input receptacle.
2. Use a flat blade screwdriver and turn the fuse capsule counter-clockwise. There is an internal spring that will push it out after turning.
3. Pull out the glass tube fuse inside to check and replace as necessary.
4. Insert the fuse capsule in the same location and use the flat blade screwdriver to turn clockwise.

5. The fuse capsule will now be locked and secured.

2.2 Preliminary Check

Complete the following steps to verify that the generator is ready for use.

- 1. Verify AC Input Voltage**

Verify and check to make sure proper AC voltages are available to power the instrument. The AC voltage range must meet the acceptable specification as explained in section 2.1.

- 2. Connect Power**

Connect AC power cord to the AC receptacle in the rear panel and press the power switch to the ON position to turn ON the instrument. The instrument will have a boot screen while loading, after which the main screen will be displayed.

- 3. Self Adjust**

At power-on, the waveform generator performs a diagnostic self-test procedure to check itself for errors.

3 Making Measurements

3.1 Open and Short Calibration

The 891 provides open/short calibration capability to have better accuracy in measuring high and low impedance. It is recommended that the user perform open/short calibration if the test leads or the test fixture has been changed.

Open Calibration

The open calibration feature compensates for any stray admittances that may exist within the test fixture or leads. Disconnect any device under test from the test leads or test fixture and make sure the test terminals are open (nothing connected). Press **SYSTEM** → **CAL** → **OPEN CAL** keys to start the open calibration.



Figure 3.1 – Open Calibration

This open calibration takes about 1 minute to complete. After it is finished, the 891 will beep rapidly to inform that the calibration is done.

Short Calibration

The short calibration feature compensates for any residual impedances that

may exist within the test fixture or leads. To perform the short calibration, connect all four terminals on the test leads or insert the Shorting Bar into the test fixture. Press **SYSTEM** → **CAL** → **SHORT CAL** keys to start the short calibration.



Figure 3.2 – Short Calibration

This short calibration takes about 30 seconds. After it is finished, the 891 will beep rapidly to inform that the calibration is done.

3.2 Parameter Entry

The test parameters on different measurement functions can vary. But, they all have similar methods to enter the parameters. The following list explains the general method of test parameter entry.

1. Use any arrow key to activate the selection cursor.



Figure 3.3 – Parameter Selection







2. Use , , , or  arrow keys to move the cursor to the corresponding parameter field for editing.
3. If the parameter is a numeric value, use the numeric keypad to enter the desired value followed by unit selection using the option softkeys.



Figure 3.4 – Digit Selection Entry

4. Or, use the  and  arrow keys on the option softkey to move the cursor left and right to selected desired digit of increase or

decrease. Use the INC or DEC on the softkey to increase or decrease the parameter value.

5. If the parameter is a selection value, press the desired selection on the option softkey.



Figure 3.5 – Selection Entry

3.3 Impedance Parameters

Components such as inductors (L), capacitors (C), and resistors (R) can respond to test signals with varying frequencies and levels in different ways. Large capacitors tested at high frequencies can respond differently than when tested at lower frequencies. Large inductors tested at low frequencies can respond differently than when tested at higher frequencies. In contrast, resistors will respond relatively the same at high or low frequencies. Due to these characteristics, it is very important to understand the complex impedance parameters of the electronic components. The 891 LCR meter allows users to vary these test signals' measurement frequency, measurement level, and equivalent circuit choice to characterize the component under test.

When we analyze the impedance using the impedance measurement plane (Figure 3.6), it can be visualized by the real element (Resistance) on the X-axis and the imaginary element (Reactance) on the Y-axis. This impedance

measurement plane can also be seen as polar coordinates. $|Z|$ is the magnitude and θ is the phase of the impedance.

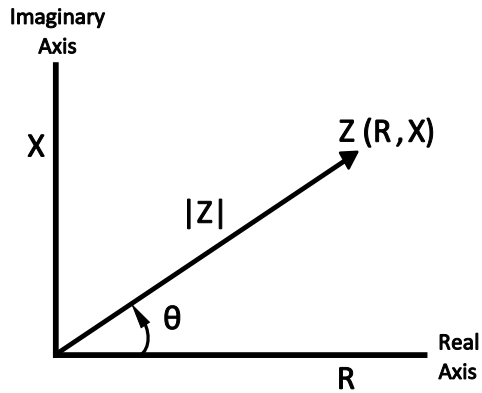

Figure 3.6 – Complex Impedance Plane

$$Z = R + jX = |Z| \angle \theta \ (\Omega)$$

$$R = |Z| \cos \theta \qquad X = |Z| \sin \theta$$

$$|Z| = \sqrt{R^2 + X^2} \qquad \theta = \tan^{-1} \left(\frac{X}{R} \right)$$

$Z = Impedance$

$R = Resistance$

$X = Reactance$

$\Omega = Ohm$

There are two different types of reactance: Inductive (X_L) and Capacitive (X_C). It can be defined as follows:

$$X_L = \omega L = 2\pi fL \qquad X_C = \frac{1}{\omega C} = \frac{1}{2\pi fC}$$

$L = \text{Inductance (H)}$

$C = \text{Capacitance (F)}$

$f = \text{Frequency (Hz)}$

$\omega = \text{Frequency (rad/s)}$

For components, the quality factor (Q) serves as a measurement of the reactance purity. In the real world, there is always some associated resistance that dissipates power, decreasing the amount of energy that can be recovered. The quality factor can be defined as the ratio of the stored energy (reactance) and the dissipated energy (resistance). Q is generally associated with inductors and D (dissipation factor) for capacitors. Below shows the relationships between these parameters:

$$\begin{aligned} Q &= \frac{1}{D} = \frac{|X|}{R} \\ &= \frac{\omega L}{R} = \frac{1}{\omega CR} \\ &= \frac{2\pi fL}{R} = \frac{1}{2\pi fCR} \end{aligned}$$

$Q = \text{Quality Factor}$

$D = \text{Dissipation Factor}$

$C = \text{Capacitance}$

$L = \text{Inductance}$

Series and Parallel Models

Components are modeled with one of the two following equivalent circuits:

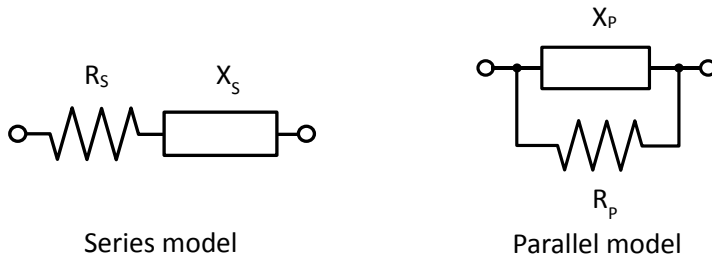

Figure 3.7 – Series and Parallel Models

The impedance for the series model is:

$$Z = R_s + jX_s$$

The impedance for the parallel model is:

$$\frac{1}{Z} = \frac{1}{R_p} + \frac{1}{jX_p}$$

These circuit models are mathematically equivalent. The LCR meter measures an impedance, which gives two independent numbers, the magnitude ($|Z|$) and phase (θ) of the impedance. These are changed into rectangular components R and X, giving the real and imaginary part of the impedance. These rectangular components can then be transformed into either a series or parallel circuit of a pure resistance and pure reactance. These transformed circuits have exactly the same impedance as the measured value, only at the measured frequency.

Choosing a Test Frequency

Test frequency can greatly affect the results of measurement reading, especially when measuring inductors and capacitors. This section provides some recommendations and suggestions to consider.

Capacitance

When measuring capacitance selecting, the right frequency is important in obtaining the most accurate measurement results. Generally, a 1 kHz and

above test frequency is used to measure capacitors that are 0.01 μF or smaller. For capacitors that are 10 μF or larger, a frequency of 1 kHz or lower can be used. Following this trend, high test frequencies are best for testing very low capacitance components. For large capacitance components, low frequency would be optimal. For example, if the capacitance of the component is to be in the mF range, then selecting in the range of 20 Hz to 200 Hz for test frequency would give much better results. The results will also be obvious because if the same component was tested with 1 kHz or above, the measured readings may look erroneous on the display.

In all cases, it is best to check with the manufacturer's data sheet in order to determine the best test frequency to use for measurement.

Inductance

Typically, a 1 kHz test frequency is used to measure inductors that are used in audio and RF circuits. This is because these components operate at higher frequencies and require that they be measured at higher frequencies above 1 kHz. However, a 120 Hz test signal is used to measure inductors that are used for applications such as filter chokes in power supplies, which are typically operated at 60 Hz AC (in U.S.) with 120 Hz filter frequencies.

In general, inductors below 2 mH should be measured at 1 kHz frequency while inductors above 200 H should be measured at 120 Hz.

In all cases, it is best to check with the manufacturer's data sheet in order to determine the best test frequency to use for measurement.

Choosing a Measurement Circuit Model

There are two measurement circuit models to choose from, **series** or **parallel**, when characterizing components under test. The LCR meter will make measurements regardless of which model is chosen, but components will display more accurate results if the correct measurement model is selected. To determine the better model to choose depends on the impedance of the component at the specified frequency.

Capacitance

The impedance in a capacitor is negatively proportional. Therefore, the larger capacitance means the lower impedance, the smaller capacitance reverts to higher impedance. Figure 3.8 shows the equivalent circuit of capacitor. If the capacitance is small, the parallel resistance (R_p) becomes large and more relevant than the series resistance (R_s). If the capacitance is large, the series resistance becomes dominant and the parallel resistance becomes insignificant. Hence, it is proper to use the parallel model for low capacitance measurement and series model for high capacitance measurement.

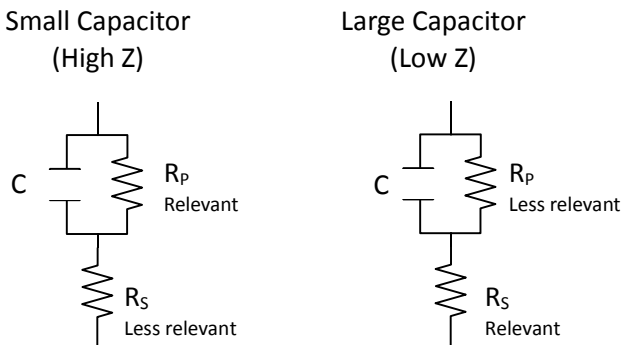

Figure 3.8 – Equivalent Capacitor Circuit

Inductance

The impedance of an inductor is positively proportional. Therefore, the larger inductances equals to higher impedance and vice versa. Figure 3.9 shows the equivalent circuit of an inductor. When the inductance is small, the series resistance (R_s) becomes more important than the parallel resistance (R_p). When the inductance is large, the parallel resistance should be taken into consideration. Therefore, it is recommended to use the series model to measure an inductor with low inductance and parallel model to measure an inductor with high inductance.

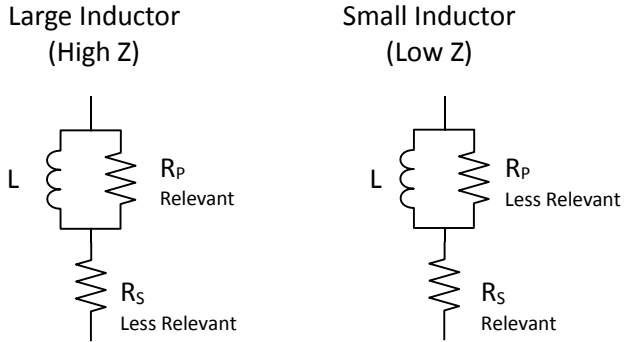

Figure 3.9 – Equivalent Inductor Circuit

What is considered high and low impedances to choose the correct circuit model? There is no exact answer, but generally if the impedance is greater than $100 \Omega^*$ use the parallel circuit model. Use the series circuit model when the impedance is less than $100 \Omega^*$.

*Note: This is only a typical value. In all cases, it is best to check with the manufacturer’s data sheet in order to determine the best model to use for measurement.

The following table translates this approximate impedance rule into inductance and capacitance values:

Table 3.1 – Series/Parallel Model Guidelines

Frequency (kHz)	Capacitors		Inductors	
	Use series model when	Use parallel model when	Use series model when	Use parallel model when
0.1	> 16 μF	< 16 μF	< 160 mH	> 160 mH
1	> 1.6 μF	< 1.6 μF	< 16 mH	> 16 mH
10	> 160 nF	< 160 nF	< 1.6 mH	> 1.6 mH
100	> 16 nF	< 16 nF	> 160 μH	> 160 μH

3.4 Configure Basic Measurement

⚠ WARNING



If the component under test is a capacitor, make sure the capacitor has been fully discharged before connecting it to the instrument. Failing to discharge the capacitor may damage the instrument and will be considered misuse.

To measure the component, connect the device under test to the test leads or insert it into the test fixture. Press **MEAS FUNC** to select desired primary measurement of C, L, Z, R or DCR. To select series or parallel mode as well as the secondary measurement parameters of Q, D, R, G, θ (not shown), and X (not shown), press the corresponding softkey to the right of the LCD.

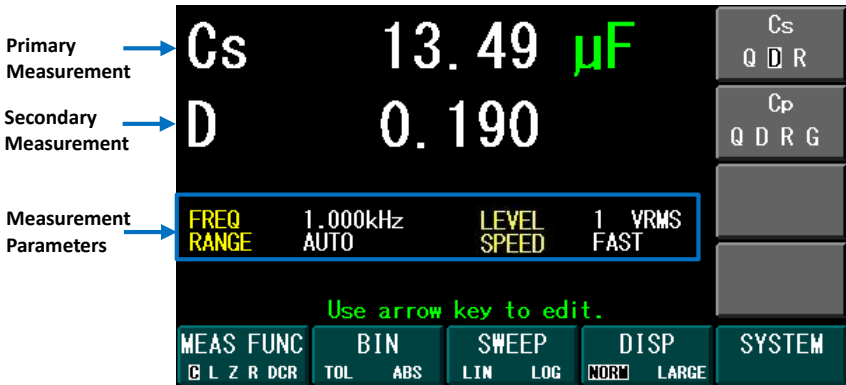

Figure 3.10 – Measurement Function Display

Primary Parameters

All primary parameters are listed below:

Table 3.2 – Primary Parameters

Parameter	Description
Cs	Capacitance value measured using a series equivalent circuit model
Cp	Capacitance value measured using a parallel equivalent circuit model
Ls	Inductance value measured using a series equivalent circuit model
Lp	Inductance value measured using a parallel equivalent circuit model
Z	Impedance value
Y	Admittance value
R	Resistance value using a specified AC frequency and level
G	Conductance value
DCR	Resistance value using a DC bias.

Secondary Parameters

All secondary parameters are listed below:

Table 3.3 – Secondary Parameters

Parameter	Description
Q	Quality factor
D	Dissipation factor
R	Equivalent resistance
G	Conductance
θ	Phase angle
X	Reactance
B	Susceptance

Parameter Combinations

The combinations of primary and secondary parameters, including the series and parallel combinations are listed below:

Table 3.4 – Parameter Combinations

Primary Parameter	Series Mode	Parallel Mode
C	Cs-Q Cs-D Cs-R	Cp-Q Cp-D Cp-R Cp-G
L	Ls-Q Ls-D Ls-R	Lp-Q Lp-D Lp-R Lp-G
Z	Z- θ	-
Y	-	Y- θ
R	R-X	-
G	-	G-B

Measurement Options

The following table lists the measurement parameter options that are configurable for a basic measurement.

Table 3.5 – Measurement Parameter Options

Parameter	Description	Input
FUNC	Specify the measurement type	All combinations
FREQ	Specify the test signal frequency	20 Hz to 300 kHz
LEVEL	Specify the test signal level	0.5 VRMS, 1

		VRMS, 1 VDC*
RANGE	Specify the measurement range control	AUTO, HOLD
SPEED	Specify the measurement speed	SLOW, FAST

*DCR mode only

Measurement Display

The number of digits of the primary and secondary measurement value can be changed from 2 to 4 digits. Also, the display notation of decimal or scientific can be selected as well. The large display enhances the readability of the measurement. The following table shows display options for the measurement function.

Table 3.6 – Measurement Display Options

Parameter	Description	Input
NOTATION	Specify the numerical notation	Decimal, Scientific
PRI. DIG.	Specify the number of digits to display for primary measurement	2, 3, 4
SEC. DIG.	Specify the number of digits to display for the secondary measurement	2, 3, 4
DISP (NORM)	When selected, all measurement parameters will be displayed on screen	
DISP (LARGE)	When selected, only the primary and secondary measurements will be displayed in a larger font.	

The following steps walk through how to configure the measurement display options:

1. Press the **DISP** function key to open the display softkey options.

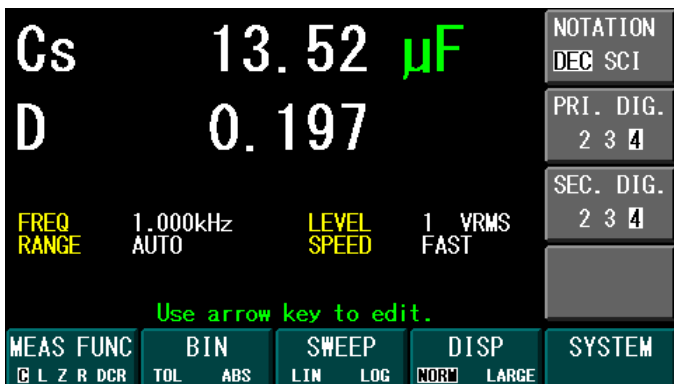

Figure 3.11 – Display Function Options

2. Press the softkey options **PRI. DIG.** or **SEC. DIG.** to select the number of digits to be displayed for the primary or secondary measurements.

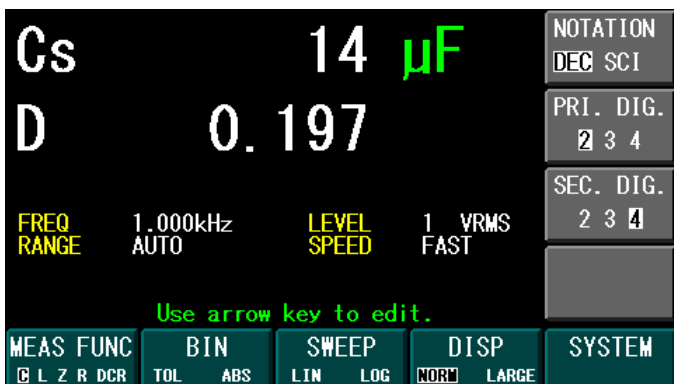

Figure 3.12 – Display Function (Primary and Secondary Digits)

3. Press the **NOTATION** softkey to select the scientific or decimal display.



Figure 3.13 – Display Function (Notation)

4. Press the **DISP** key again to show large readings on the screen.

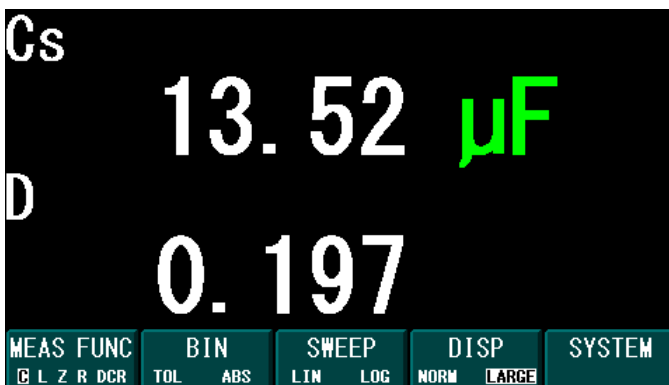

Figure 3.14 – Display Function (Large Format)

5. Press the **DISP** key to go back to normal readings display.

3.5 Bin Sorting Function

The bin sorting function is very useful for component sorting in component inspection or quality control. It has 9 Primary bins plus a Secondary bin and an Out-of-specification bin. Each bin has high and low limit values. If the measured value is within the high and low limits of the bin, the bin counter

will increment by one with beep function. The beep can be turned off or used when the component passes or fails specification. The beep tone for each bin is different so that the user can distinguish bins by listening. The bin detection sequence is from low to high. This means that the bin 1 comparator will execute first and if the measured value is not within bin 1's limits, it will execute the bin 2 comparator and so on. For instance, if both bins are set to the same limits, the larger numbered bin will not be compared because the smaller numbered bin will always count first.

To measure the value and record the count into the predefined bins, users can connect the component and press the **TRIG** softkey. If the flash drive is inserted and the Bin Log option is **ON** in the SYSTEM SETUP menu (see System Setup section), each measured value will be recorded onto the flash drive. The bin function has two modes: absolute mode and tolerance mode.

Absolute Mode

The absolute mode allows users to use absolute values for the high and low limits of each bin. The following example shows a typical setup of absolute mode.

FUNC	Cs-D	FREQ	10.00kHz	RANGE	AUTO	START	
BIN#	RESULT	LEVEL	1	VRMS	SPEED FAST		
1	0	ON/OFF	ON	LOW LMT	HIGH LMT	BEEP OFF PASS FAIL	
2	0	ON	ON	43.00µF	43.50µF		
3	0	ON	ON	43.50µF	44.00µF	SWAP	
4	0	ON	ON	44.00µF	44.50µF		
5	0	ON	ON	44.50µF	45.00µF	CLEAR	
6	0	ON	ON	45.00µF	45.50µF		
7	0	ON	ON	45.50µF	46.00µF	SYSTEM	
8	0	OFF	OFF	46.00µF	46.50µF		
9	0	OFF	OFF	--	--	MEAS FUNC	
SEC	0	OFF	OFF	--	--		BIN
OUT	0	Use arrow key to edit.					SWEEP
							DISP
							SYSTEM
							C L Z R DCR
							TOL ABS
							LIN LOG
							BIN TBL HIST

Figure 3.15 – Bin Mode Table View (Absolute Mode)

The following graph is a visual representation of the Bin absolute mode setup demonstrated in Figure 3.16.

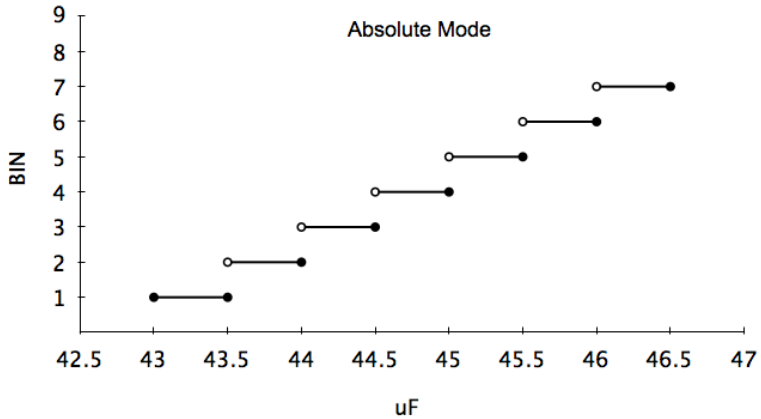

Figure 3.16 – Bin Setup Absolute Mode Graph

Tolerance Mode

The tolerance mode allows the user to set high and low limits value by percentage of a nominal value. The following example shows a typical setup of tolerance mode.

FUNC	Cs-D	FREQ	10.00kHz	RANGE	AUTO	START
NOM	45.00uF	LEVEL	1	VRMS	SPEED FAST	
BIN#	RESULT	ON/OFF	LOW LMT	HIGH LMT		OFF PASS FAIL
1	0	ON	-1.000 %	1.000 %		SWAP
2	0	ON	-2.000 %	2.000 %		
3	0	ON	-3.000 %	3.000 %		CLEAR
4	0	ON	-4.000 %	4.000 %		
5	0	ON	-5.000 %	5.000 %		SYSTEM
6	0	ON	-6.000 %	6.000 %		
7	0	ON	-7.000 %	7.000 %		
8	0	ON	-10.00 %	10.00 %		
9	0	ON	-20.00 %	20.00 %		
SEC	0	ON	0.000	0.000		
OUT	Use arrow key to edit.					
MEAS FUNC	BIN	SWEEP	DISP	SYSTEM		
C L Z R DCR	TOL ABS	LIN LOG	BIN TBL HIST			

Figure 3.17 – Bin Mode Table View (Tolerance Mode)

The following graph is a visual representation of the Bin tolerance mode setup demonstrated in Figure 3.18.

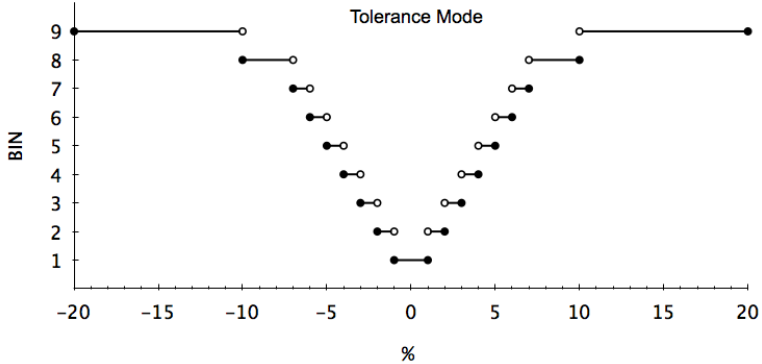

Figure 3.18 – Bin Setup Tolerance Mode Graph

Secondary comparator bin

If the measured component primary value is within any of the Primary bin limits and the measured secondary parameter value is not within the Secondary bin limits, the secondary bin count will increment by one. If the measured primary value and secondary value are not within the high/low limits of any bins, the Out bin count will increment by one.

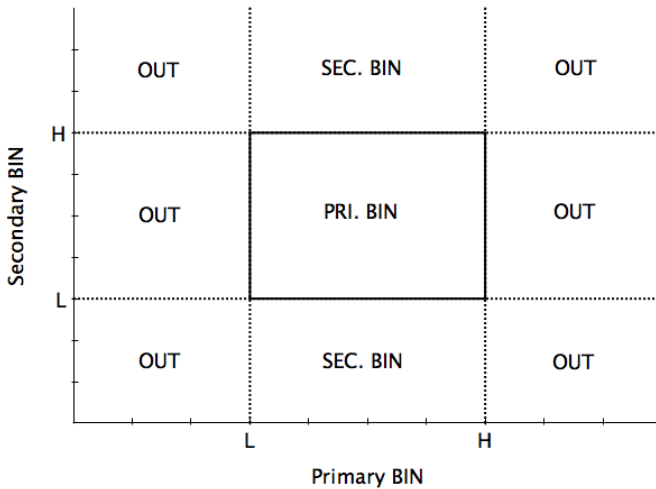

Figure 3.19 – Bin Priorities

The bin function has three different display screens to present results of the comparisons: Bin, Table, and Histogram. The manual trigger to count can be accessed in any of these displays.

Bin Display

This screen shows the measured value as well as the compared bin number.

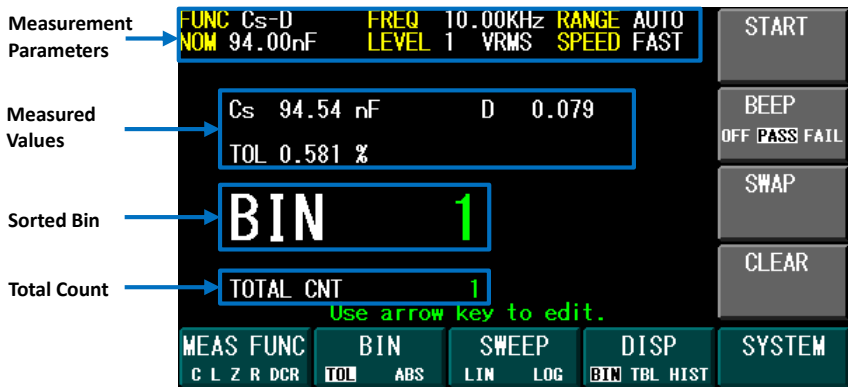

Figure 3.20 – Bin Main Display

Table Display

The table display shows the overall result of the bin function. It shows the result, the comparator enable switch and high/low limit values of each bin. The comparator setting can be accessed in this display screen.

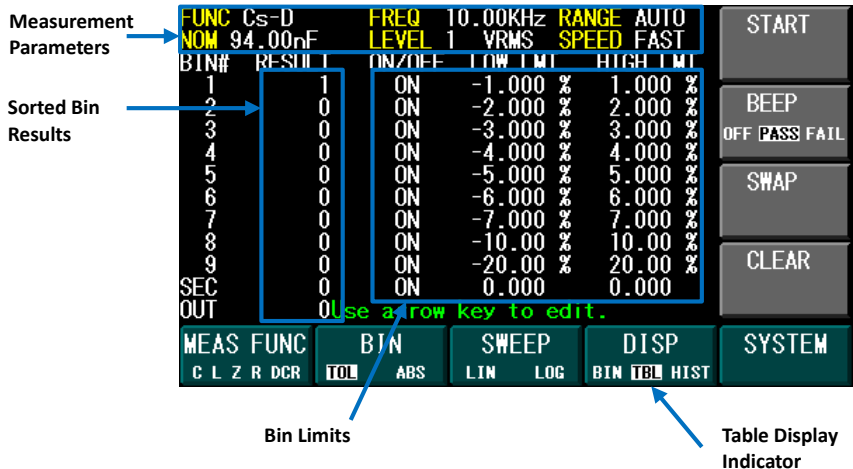

Figure 3.21 – Bin Table Display

Histogram Display

The screen shows the histogram chart of the bin function result.

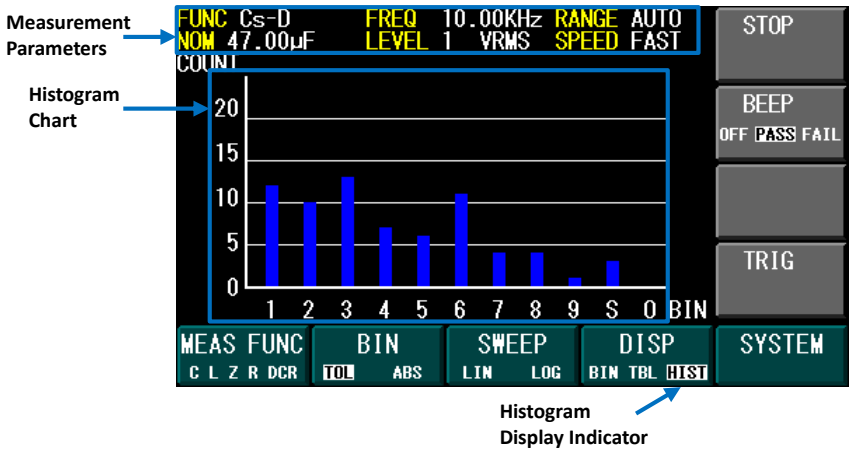

Figure 3.22 – Bin Histogram Display

Configure Bin Function

The following table shows the different parameters that can be configured in the Bin function.

Table 3.7 – Bin Parameter Options

Parameter	Description	Input
FUNC	Specify the measurement type	All combinations
NOM*	Specify the nominal component value	Valid component range
FREQ	Specify the test signal frequency	20 Hz to 300 kHz
LEVEL	Specify the test signal level	0.5 VRMS, 1 VRMS, 1 VDC**
RANGE	Specify the measurement range control	AUTO, HOLD
SPEED	Specify the measurement speed	SLOW, FAST
SWAP	Specify primary or secondary measurement	PRI, SEC

*Tolerance mode only

**DCR measurement only

To perform the bin function, press the **BIN** function key to enter the bin softkey menu. The default mode is tolerance mode.



Figure 3.23 -- Bin Mode View (Tolerance Mode)

Press the **BIN** function key again to switch between tolerance and absolute mode.



Figure 3.24 – Bin Mode View (Absolute Mode)

Press the arrow keys to select the test parameters and use the option softkeys to edit and set them.

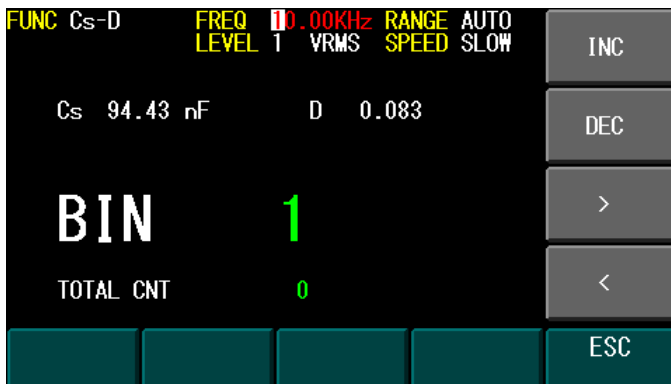

Figure 3.25 - Bin Parameter Edit

To edit the high/low limits values and comparator ON/OFF for each bin, press **DISP** key to enter the table display. Use arrow key to activate the cursor and edit the corresponding values.

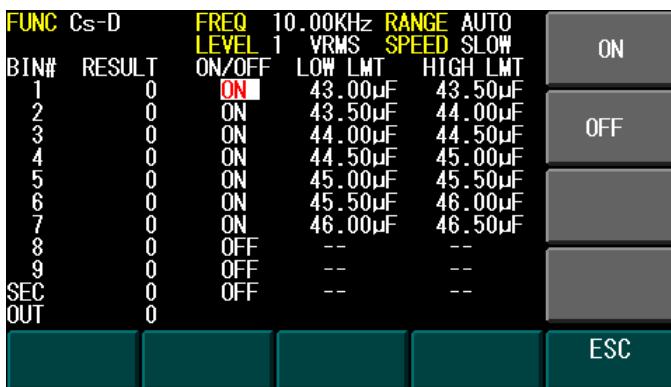

Figure 3.26 – Bin Enable/Disable

To start the bin comparator function, do the following steps:

1. Select the desired beep function by press the **BEEP** softkey.
2. The **SWAP** softkey will swap the primary and secondary measurement to be the main bin comparison.
3. Press the **START** softkey to start the bin comparison.

4. Connect the component under test to the test leads or insert it into the test fixture.
5. Press the **TRIG** key to perform a bin comparison and log the corresponding bin count result.
6. Remove the device under test from the test leads or test fixture.
7. Repeat steps 1 – 3 for more components to be tested.
8. Press the **STOP** softkey to stop the bin comparison.
9. Use the **CLEAR** softkey to clear the bin count results.

NOTE: You may save the bin comparison test results to an external USB flash drive. To do so, please refer to the Save a Measurement Result section.

3.6 Sweep Function

The sweep function scans the frequency over the component under test. It shows a full spectrum of the component characteristics in a very easy to operate method. It can also sweep the frequency linearly or logarithmically to provide better understanding of the component. Users can also view data either by a graph or by a table and obtain up to 300 points in one sweep.

Linear Sweep Mode

In linear sweep mode, the unit will sweep the frequency linearly from start frequency to stop frequency. The following will be displayed for the “GRAPH” display:

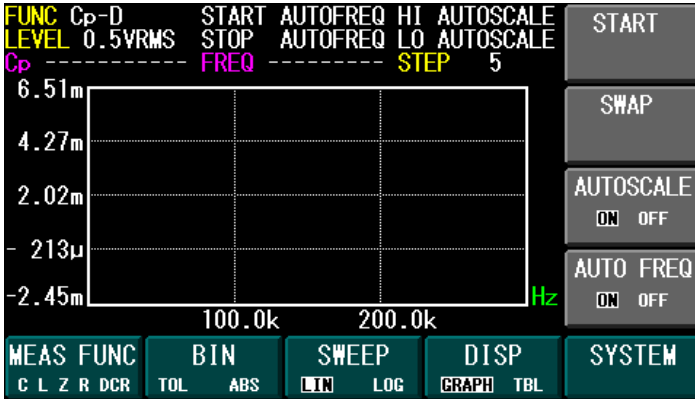

Figure 3.27 – Sweep Linear Display

Logarithmic Sweep Mode

In logarithmic sweep mode, it will sweep the frequency logarithmically from start frequency to stop frequency. The following will be displayed for the “GRAPH” display:

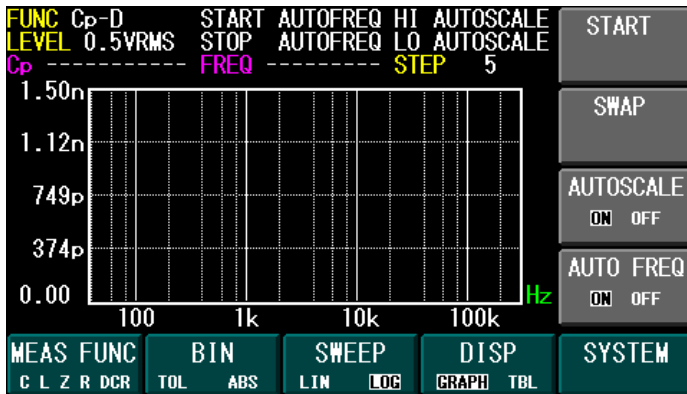

Figure 3.28 – Sweep Logarithmic Display

Table Display

The table display shows the overall result of the linear or logarithmic sweep. It shows the step number, frequency, and component value in a table form.

Using the **PG UP** or **PG DN** softkey options will scroll the table up or down. Up to 300 points (depending on sweep settings) can be displayed in table display. If interpolation is turned on, interpolated data will be shown in orange. The result table can be accessed using the **DISP** function key.

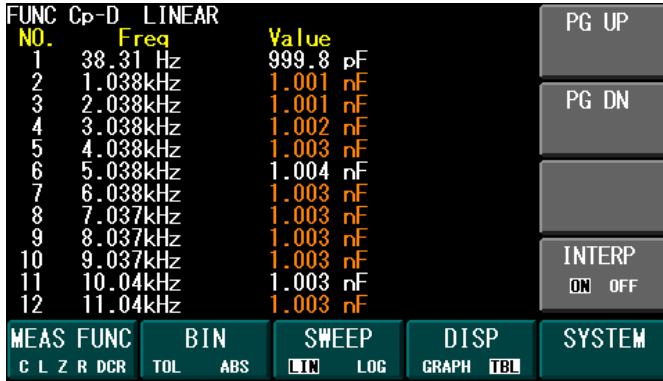

Figure 3.29 – Sweep Table Display (with INTERP ON)

NOTE: You may save the table sweep results to an external USB flash drive. To do so, please refer to the Save a Measurement Result section.

Configure Sweep Function

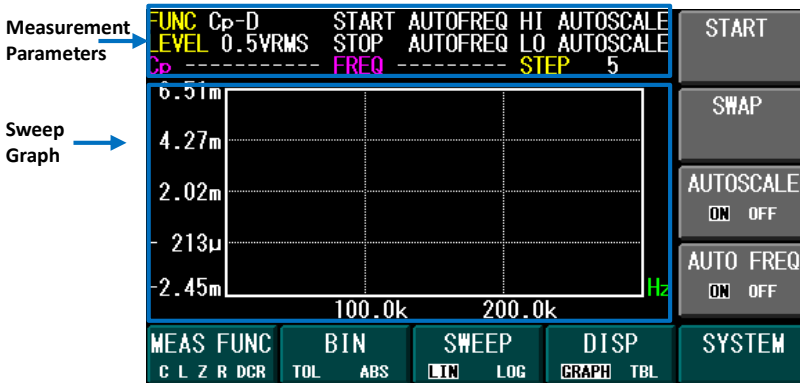

Figure 3.30 - Sweep Function

There are many parameters that may be configured for each sweep. The following table are the different parameters that can be setup in the Sweep function.

Table 3.8 – Sweep Parameter Selections

Parameter	Description	Input
FUNC	Specify the type of sweep measurement	All combinations (Except DCR)
LEVEL	Specify the sweep voltage level	0.5 VRMS, 1 VRMS
START	Specify the sweep start frequency (X-Axis)	20 Hz to 300 kHz
STOP	Specify the sweep stop frequency (X-Axis)	20 Hz to 300 kHz
HI	Specify the high display value scale (Y-Axis)	
LOW	Specify the low display value scale (Y-Axis)	
STEP	Specify the frequency sweep step and limit number of measured points	1, 2, 5, 10
SWAP	Specify primary or secondary sweep measurement	PRI, SEC

AUTOSCALE	If enabled (ON), the unit will automatically select the HI and LO values (Y-axis) to properly display the frequency sweep on the display graph. If disabled (OFF), the manually set user values will be used.	ON, OFF
AUTOFREQ	If enabled (ON), the unit will automatically select the start and stop frequency based on an initial analysis of the component connected to the input and the initial start and stop frequency that is set. The start and stop frequency are then adjusted automatically to ensure sufficient interval/spacing between each frequency points of the sweep.	ON, OFF
INTERP	If enabled (ON), the unit will show interpolated data in table view and return interpolated data in remote mode.	ON, OFF

The following table specifies the number of points generated with interpolation enabled and disabled.

Table 3.9 - Step Parameter Points

Step Parameter	Number of Points (INTERP ON)	Number of Points (INTERP OFF)
1	300	300
2	300	150
5	300	60
10	300	30

To run the sweep function, perform the following steps:

1. Press the **SWEEP** function key to enter the sweep function.
2. Press the **DISP** function key to select linear or logarithmic scale.
3. Press the **SWAP** softkey if the secondary value is desired to be swept.

4. Use the arrow keys to edit the desired measurement parameters such as level, start frequency, stop frequency, high and low values of the Y-Axis (if AUTOSCALE is ON, the meter will automatically scale the Y-axis), and the step value. Step can be set to 1, 2, 5, and 10 points per sweep step.
5. Turn **AUTOFREQ ON** if you would like the meter to automatically select the start and stop frequency.
6. Turn **INTERP ON** if you would like to have interpolated data included in the sweep result (only valid if step is 2, 5, or 10). Connect the test leads to the component under test or insert component into the test fixture.
7. Press the **START** softkey to execute the sweep function with the current parameters. The display will do an initial scan and analyze the component connected to the input to determine the frequency sweep range (if **AUTOFREQ** is **ON**). The below screen will display during the scan.

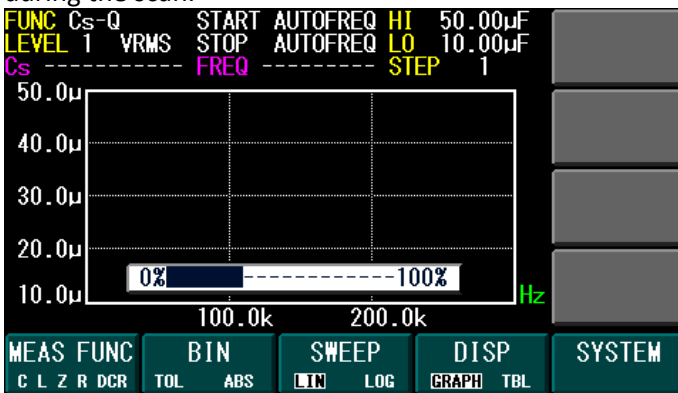

8. If needed, press the **STOP** softkey to terminate the sweep function immediately.
9. While sweeping, the instrument may occasionally display the below screen if a measurement requires more than 1000 ms to complete. This is normal.

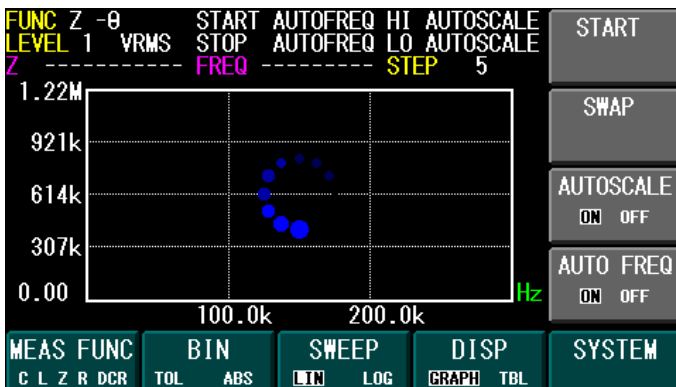

10. After the sweep is completed, the display will show one of the following graphs:

Note: When sweep is completed, if you press any of the arrow keys to select or change any of the sweep parameters, all data will be cleared.

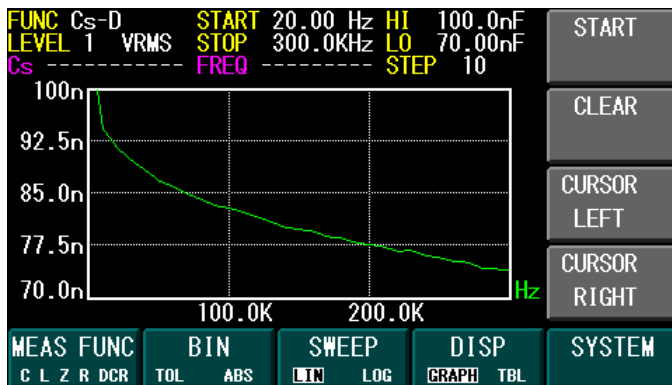

Figure 3.31 – Post Linear Sweep Display

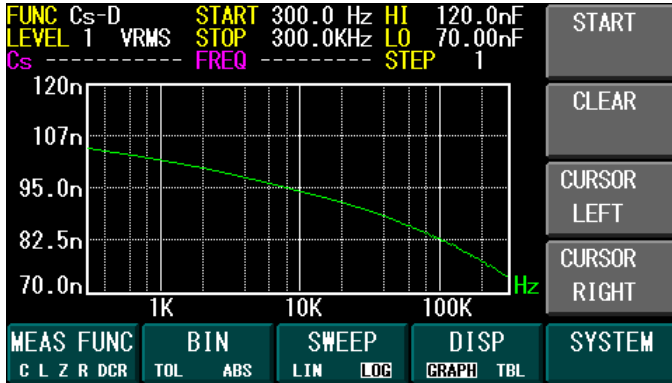

Figure 3.32 – Post Logarithmic Sweep Display

11. Use the **CURSOR LEFT** or **CURSOR RIGHT** softkeys to change the cursor position of the frequency on the curve to read the measured value at that frequency.

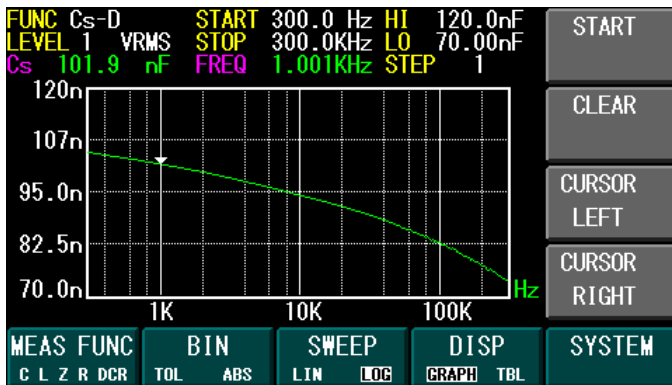

Figure 3.33 – Post Sweep Point Selection

12. To view all the points for frequency and component values in a table form, press the **DISP** function key.

FUNC Cp-D LOGARITHM										
NO.	Freq	Value								
1	20.00 Hz	996.3 pF	PG UP							
6	23.48 Hz	998.2 pF	PG DN							
11	27.56 Hz	1.008 nF								
16	32.35 Hz	1.001 nF								
21	37.97 Hz	1.005 nF								
26	44.57 Hz	1.003 nF								
31	52.32 Hz	1.000 nF								
36	61.41 Hz	1.004 nF								
41	72.08 Hz	1.004 nF								
46	84.61 Hz	1.004 nF	INTERP							
51	99.32 Hz	1.004 nF	ON OFF							
56	116.6 Hz	1.004 nF								
MEAS FUNC		BIN		SWEEP		DISP		SYSTEM		
C	L	Z	R	DCR	TOL	ABS	LIN	LOG	GRAPH	TBL

Figure 3.34 - Points Table without Interpolation

FUNC Cp-D LOGARITHM										
NO.	Freq	Value								
1	20.00 Hz	996.3 pF	PG UP							
2	20.65 Hz	996.7 pF	PG DN							
3	21.32 Hz	997.1 pF								
4	22.02 Hz	997.5 pF								
5	22.74 Hz	997.8 pF								
6	23.48 Hz	998.2 pF								
7	24.24 Hz	1.000 nF								
8	25.03 Hz	1.002 nF								
9	25.85 Hz	1.004 nF								
10	26.69 Hz	1.006 nF								
11	27.56 Hz	1.008 nF	INTERP							
12	28.45 Hz	1.007 nF	ON OFF							
MEAS FUNC		BIN		SWEEP		DISP		SYSTEM		
C	L	Z	R	DCR	TOL	ABS	LIN	LOG	GRAPH	TBL

Figure 3.35 - Points Table with Interpolation

- When finished, you may clear the sweep data by using the **CLEAR** softkey option.

4 System

The system menu allows the user to view the system information, configure system setup and communication setup. Press the **SYSTEM** function to enter this submenu.



Figure 4.1 – System Submenu

System Information

Press the **SYSTEM INFO** function key to view the system information. The following screen will be shown.



Figure 4.2 – System Information

In the system information page, the user can view the following:

- Model
- Serial Number
- UI Firmware Version/Hardware Version/GPIB Version
- Real Time Clock Battery Information
- Front USB Identification
- USB Product Information
- GPIB Address
- MAC Address
- Current IP Address

- Current Subnet Mask
- Current Gateway

Clear Errors

In this menu page, the user also has the ability to clear any errors, as indicated in the bottom right corner of the screen with a red “ERR”, which may occur. To do so, press the **CLEAR ERROR** option softkey to clear all errors. This has the same effect as sending the “*CLS” command (see SCPI Common Commands section) remotely.

Set to Factory Default

To set instrument settings to factory default, press the **RESET** option softkey. The instrument will change all settings to default and the screen will return to the main measurement display.

Below is a table of the factory default settings:

Table 4.1 – Default Settings

Parameter	Default Setting
Mode	Measurement
Primary measurement	Parallel Capacitance (Cp)
Secondary measurement	Dissipation Factor (D)
Test frequency	1.000 kHz
Test level	1 VRMS
Test range	Auto
Test speed	Slow
Display font	Normal
Display notation	Decimal
Primary digit	4
Secondary digit	4
Bin mode	Tolerance
Bin mode display	Bin
Bin beep	Off

Sweep display	Linear
Sweep start frequency	20.00 Hz
Sweep stop frequency	300.0 kHz
Sweep Autoscale	On
Sweep step	1
System LCD brightness	9
System beep	On
System Bin Log	On
System communication GPIB address	01
System communication IP mode	Auto

System Setup

To edit the system setup, press the **SYSTEM SETUP** function key. Use the arrow keys to edit system settings such as date, time, LCD brightness, system beep, Bin Log function, and the Auto Scale for the sweep mode. The following table describes the available setup options.

Table 4.2 – System Setup Menu

Parameter	Description	Input
Date	Set the date (YY/MM/DD)	Numeric Keys
Time	Set the time in 24 hour format (HH:MM:SS)	Numeric Keys
Brightness	Set the LCD brightness level	Numeric Keys (0-9)
Beep	Configure the system beep	ON/OFF
Bin Log	Configure data logging to external USB flash for bin mode	ON/OFF

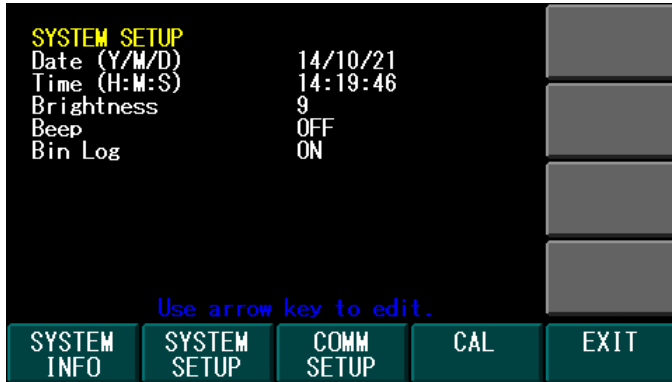

Figure 4.3 – System Setup Screen

Bin Log

When Bin Log setting is enabled (ON) in the System Setup, it allows for the LCR meter to log measurement results directly to the connected USB flash drive. The LCR meter will create a folder called “LOG” in the flash drive and store the bin log files (BLOGxxxx.TXT) in this folder. The feature will work in both absolute mode and tolerance mode. The following is a sample of the generated data log:

```

BIN TOLERANCE
Cs-D  FREQ  1.000 kHz RANGE  AUTO
NOM 22.00uF  LEVEL 1  VRMS  SPEED  FAST
BIN#   LOW LMT   HIGH LMT
  1    -1.000 %   1.000 %
  2    -2.000 %   2.000 %
  3    -5.000 %   5.000 %
  4   -10.00 %  10.00 %
  5     --        --
  6     --        --
  7     --        --
  8     --        --
  9     --        --
SEC     --        --
TEST RESULT
NO.    Value                BIN#
  1    Cs :    22.8uF        3
  2    Cs :    22.8uF        3
  3    Cs :    22.8uF        3
  4    Cs :    22.8uF        3
Date:   2014/04/29
Time:   16:48:01

```

Figure 4.4 – Bin Log Text Result

Communication Setup

Press the **COMM SETUP** function key to edit the communication setup such as GPIB address, IP mode, IP address, subnet mask, and gateway. The following parameters will be displayed.

Table 4.3 – Communication Setup Menu

Parameter	Description	Input
GPIB Address	Set the GPIB address	Numeric Keys (1-30)
IP Mode	Configure the IP mode to setup the LAN as DHCP (Auto) or static (Manu)	AUTO/MANU
IP Address	Set the instrument IP address	Numeric Keys

Subnet Mask	Set the instrument Subnet Mask	Numeric Keys
Gateway	Set the instrument Gateway	Numeric Keys

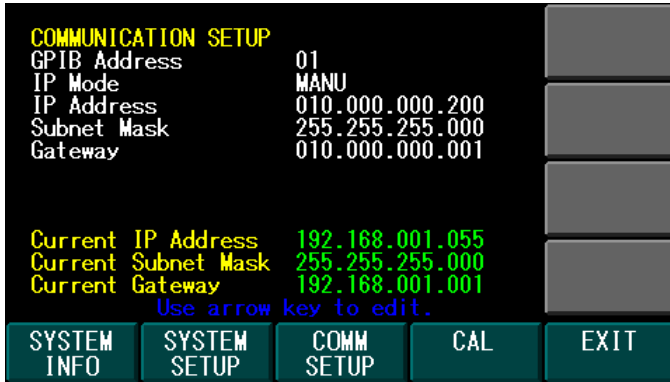

Figure 4.5 – Communication Setup Screen

For further information on the communication setup, see Interface Configuration section.

5 Save/Recall

The 891 has built-in non-volatile memory that can store 10 sets of measurement configurations. With an external USB flash drive, users can store an additional 90 sets of measurement configurations and up to 1000 sets each of measurement data results and screen captures. Before Save/Recall is executed, insert the USB flash drive into the front USB flash drive port. A short message indicates the USB flash drive has been attached and recognized, as shown below.

Note: The USB flash drive is compatible with most FAT32 formatted flash drives.



Figure 5.1 – USB Flash Detect Message

When the **SAV** button is selected, the following options screen will appear and allow the user to save a measurement configuration (CONFIG), measurement data results (MEAS), or a screen capture (SCREEN).

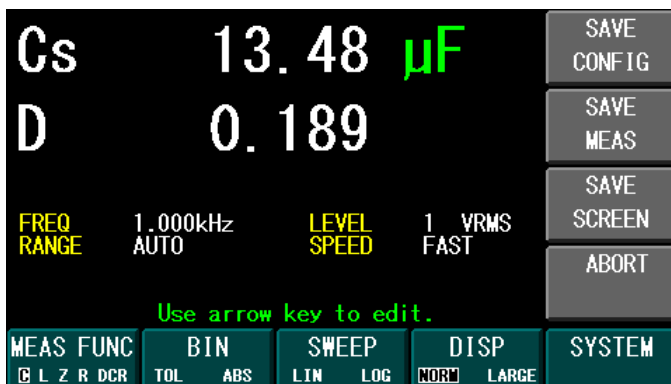

Figure 5.2 - Save Menu

The file folders that store the measurement configuration (CFG), measurement result (RLT), and LCD screen (BMP) will be created by the LCR meter and stored on the USB flash drive.

Save/Recall a Measurement Configuration

The following measurement parameters will be saved or recalled during this operation.

Table 5.1 – Save/Recall Parameters

Measurement state of single measurement, bin function, or sweep function
Primary measurement of C, L, R, Z, and DCR
Secondary measurement of D, Q, R, G
Test frequency
Test level
Test range
Test speed
Display normal or large
Display notation
Primary digit
Secondary digit
Bin mode of tolerance or absolute
Bin display of bin, table or histogram
Bin beep of off, pass or fail
Bin swap of primary and secondary
Bin nominal value of tolerance mode
Bin comparator on/off switch of bin 1-9 and secondary bin in tolerance mode
Bin high/low limits of bin 1-9 and secondary bin in tolerance mode
Bin comparator on/off switch of bin 1-9 and secondary bin in absolute mode
Bin high/low limits of bin 1-9 and secondary bin in absolute mode
Sweep display of linear or logarithm
Sweep start frequency
Sweep stop frequency
Sweep high value of the graph scale
Sweep low value of the graph scale

Sweep step
Sweep swap of primary and secondary
Sweep Autoscale
System LCD brightness
System beep
System communication GPIB address
System communication IP mode of manual or auto
System communication IP address
System communication subnet mask
System communication gateway address

The file name of the measurement configuration is 891CFGxx.CFG, where the xx represents the location (00 to 99) in internal non-volatile memory or external USB flash drive. The number 00 to 09 is designated to be the internal non-volatile memory and the number 10 to 99 is in the external USB flash drive.

Save a Measurement Configuration

To save the measurement configuration, press the  key first and then press the **SAVE CONFIG** softkey option to show the save configuration pop-up window.

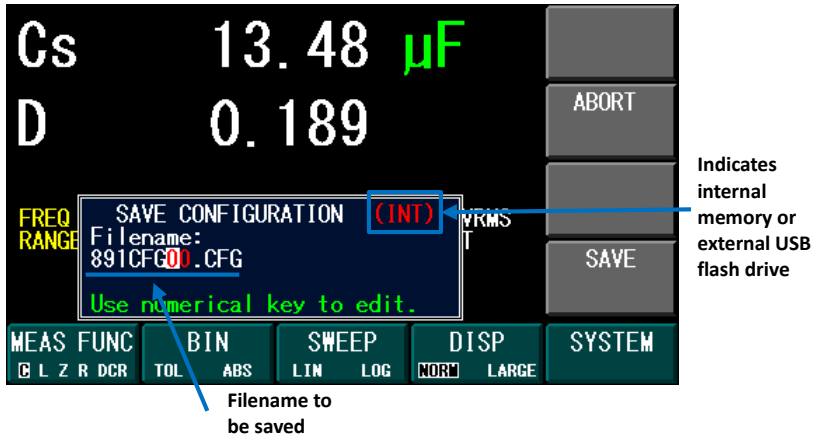

Figure 5.3 – Save Configuration Pop-Up Window

Use the numeric keypad to edit the desired location in the memory, from 00 to 99 in the memory, from 00 to 09, Press **SAVE** softkey option to execute the save function or press **ABORT** to close the save configuration pop-up window. The “891CFGxx.CFG File Saved !” message will be displayed on the screen, if saved successfully, a message will pop up as shown below.



Figure 5.4 – Save Confirmation Message

Recall a Measurement Configuration

To recall the measurement configuration, press the **RCL** key first and then press the **RECALL CONFIG** softkey to show the save configuration pop-up

window.



Figure 5.5 – Recall Configuration Pop-Up Window

Use the numeric keypad to enter the desired file number to be recalled or use the **NEXT FILE** softkey option to select the next available configuration file that has been stored in the internal memory or external flash drive. Press the **EXEC** softkey option to execute the recall configuration file or press the **ABORT** softkey option to close the recall configuration pop-up window.

Save a Measurement Result

The measurement result can be saved to an external USB flash drive. The format of the saved result is the text file that can be opened by any text editor program, such as notepad. Three types of measurement results can be saved: single measurement, bin test, and sweep test.

```

SINGLE MEASUREMENT
-----
Date:          2014/04/29
Time:          16:37:55
FREQ          : 1.010 kHz
LEVEL         : 1 VRMS
RANGE         : AUTO
SPEED         : SLOW
Cs : 45.02 uF
D : 0.174

```

Figure 5.6 – Single Measurement Text Result

```

BIN TOLERANCE MEASUREMENT
-----
Date:          2014/04/29
Time:          16:41:40
FUNC Cs-D     FREQ 1.010 kHz RANGE AUTO
NOM 47.00uF   LEVEL 1 VRMS SPEED SLOW
BIN# RESULT  ON/OFF  LOW LMT  HIGH LMT
  1      0      ON     -1.000 %  1.000 %
  2      0      ON     -2.000 %  2.000 %
  3      0      ON     -3.000 %  3.000 %
  4      2      ON     -4.000 %  4.000 %
  5      5      ON     -5.000 %  5.000 %
  6      2      ON     -6.000 %  6.000 %
  7      0      ON     -7.000 %  7.000 %
  8      6      ON    -10.00 %  10.00 %
  9      0      ON    -20.00 %  20.00 %
SEC      0      ON      0.050    0.200
OUT      0

```

Figure 5.7 – Tolerance Bin Measurement Text Result

```

BIN ABSOLUTE MEASUREMENT
-----
Date:          2014/04/29
Time:          16:42:01
FUNC Cs-D     FREQ 1.010 kHz RANGE AUTO
              LEVEL 1 VRMS SPEED SLOW
BIN#  RESULT  ON/OFF  LOW LMT  HIGH LMT
  1     6      ON     43.00uF  43.50uF
  2     2      ON     43.50uF  44.00uF
  3     5      ON     44.00uF  44.50uF
  4     1      ON     44.50uF  45.00uF
  5     1      ON     45.00uF  45.50uF
  6     0      ON     45.50uF  46.00uF
  7     0      ON     46.00uF  46.50uF
  8     0      OFF     --       --
  9     0      OFF     --       --
SEC    0      ON     0.010    0.100
OUT    0

```

Figure 5.8 – Absolute Bin Measurement Text Result

```

SWEEP MEASUREMENT
-----
Date:          2014/04/29
Time:          16:42:57
HIGH          : 50.00uF
LOW           : 10.00uF
STARTFREQ    : 20.00 Hz
STOPFREQ     : 300.0 kHz
LEVEL        : 1 VRMS
SCALE        : LINEAR
  1 FREQ:     20.000 Hz Cs : 60.85 uF
  2 FREQ:   1019.933 Hz Cs : 45.01 uF
  3 FREQ:   2019.867 Hz Cs : 44.08 uF
  4 FREQ:   3019.800 Hz Cs : 43.79 uF
  5 FREQ:   4019.733 Hz Cs : 43.35 uF
          .
          .
          .
299 FREQ:298000.125 Hz Cs : 18.12 uF
300 FREQ:299000.063 Hz Cs : 17.96 uF
301 FREQ:300000.000 Hz Cs : 18.61 uF

```

Figure 5.9 – Sweep Measurement Text Result

To save the test result, first, make the measurement of desired test such as single measurement, bin, or sweep. Press the **SAV** key and press the **SAVE MEAS** softkey option to show the save measurement pop-up window. The file name of the measurement result is 891RLTxxx.TXT, where xxx represents 000 to 999 locations in the external USB flash drive.

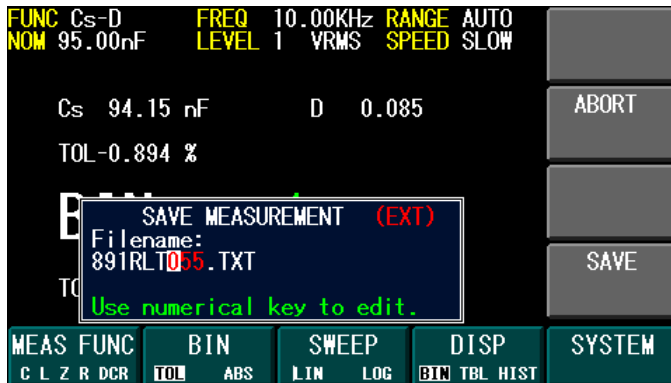

Figure 5.10 – Save Measurement Pop-Up Window

Use the numeric keypad to edit the desired location from 000 to 999 in the memory. Press the **SAVE** softkey option to execute the save function or press **ABORT** to close the save configuration pop-up window. If saved successfully, the “891RLTxxx.TXT File Saved !” message will be displayed on the screen.

Save a Screenshot

The contents on the LCD screen can be captured using the screenshot function. It will create a bitmap file of the entire 480 x 272 pixels of screen. The file name of the LCD screen is 891SCRxxx.BMP, where xxx represents the 000 to 999 locations in the external USB flash drive. To make a screenshot of the LCD screen, press the **SAV** key and press the **SAVE SCREEN** softkey option to show the save screen pop-up window, as shown below.

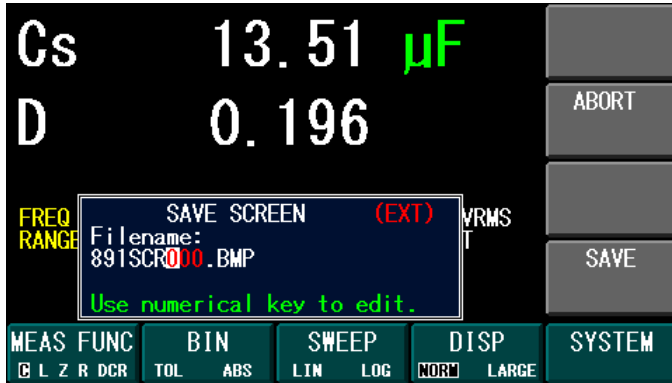



Figure 5.11 – Save Screenshot Pop-Up Window

Use the numeric keypad to edit the desired location from 000 to 999 in the memory. Press the **SAVE** softkey option to execute the save function. Or, press **ABORT** to close the save screen pop-up window. If saved successfully, the “891SCRxxx.BMP File Saved !” message will be displayed on the screen.

6 Remote Interface

The instrument comes with USB (virtual COM), GPIB, and LAN interfaces for remote control. This chapter will describe how users can remotely operate the instrument and use SCPI (Standard Commands for Programmable Instruments) commands over any one of these remote interfaces.

NOTE: The green **RMT** indicator will appear on the lower right of the display when the LCR meter is successfully connected to a PC remotely through any remote interface. Keys on the front panel will be locked until the instrument is in LOCAL mode. To return to LOCAL mode from the front panel, press the  key. The RMT indicator will disappear when the instrument is in LOCAL mode.

6.1 Interface Configuration

USB (Virtual COM)

The standard USB port is a virtual COM port that can be used for remote communication. There are no settings in the menu system for USB configuration. The serial settings are listed below:

Parameter	Description
Baud rate	9600, 19200, 38400, 57600
Parity and data bit	None/8 bits, Even/8 bits, Odd/8 bits
Stop bit	1, 2
Flow control	None

NOTICE

The USB interface does not support hardware flow control (only transmit, receive, and ground pins are used). The programmer should be aware of this limitation and notice the command process time of the LCR meter. If the remote commands are sent too fast to the LCR meter, the internal buffer may overrun and cause a communication error. Therefore, adding a delay between commands is necessary to allow time for the meter to process.

GPIB

The GPIB address of the LCR meter can be configured from 1-30. To communicate via GPIB, connect a GPIB cable to the GPIB port at the back of the LCR meter. Follow the instructions below to select and configure the GPIB interface for remote operation.

1. From the **SYSTEM** menu, select the **COMM SETUP** function key.
2. From the **COMM SETUP** menu, press any arrow key to highlight the first parameter, **GPIB Address** in this case.
3. Once **GPIB Address** is highlighted, use the numeric keypad to input the GPIB address (1-30 is valid) and press the **ENTER** softkey option.
4. Press **ESC** to exit editing parameters.

LAN (Ethernet)

There are three ways to control the LCR meter via LAN interface: Web server, Telnet connection, and Socket connection.

Follow the instructions below to select the Ethernet interface and configure it for remote operation.

1. From the **SYSTEM** menu, select the **COMM SETUP** function key.
2. From the **COMM SETUP** menu, press the down arrow key multiple times to highlight the **IP Mode** parameter. You have the option between **AUTO** and **MANU**. Selecting **AUTO** will allow the unit to request an IP Address, Subnet Mask, and Gateway automatically in order to communicate properly. No other configuration is necessary once **AUTO** is selected.

NOTE: The unit must already be connected via Ethernet connection and the connected network/router must be compatible to assign the correct parameters to the instrument.

Selecting **MANU** will allow the user to manually enter the IP Address, Subnet Mask, and Gateway of the instrument.

3. If **MANU** is selected, press the down arrow key to highlight the **IP Address** parameter and enter using the numeric keypad (i.e. IP Address: 192.168.100.55).
4. Repeat step 3 for the **Subnet Mask** and **Gateway** parameters.
5. Press **ESC** to exit editing parameters.

Web Server

There is an embedded web server GUI that can access the LCR meter via LAN interface using a web browser. The GUI provides a simple way of setting measurement parameters, sending SCPI commands, making measurements, as well as viewing system information using a web browser from a computer connected to the same local area network as the instrument. To access this, perform the following steps:

1. Open up a web browser on the computer
2. Check the IP address of the LCR meter by pressing the **SYSTEM** function key and the **SYSTEM INFO** key.

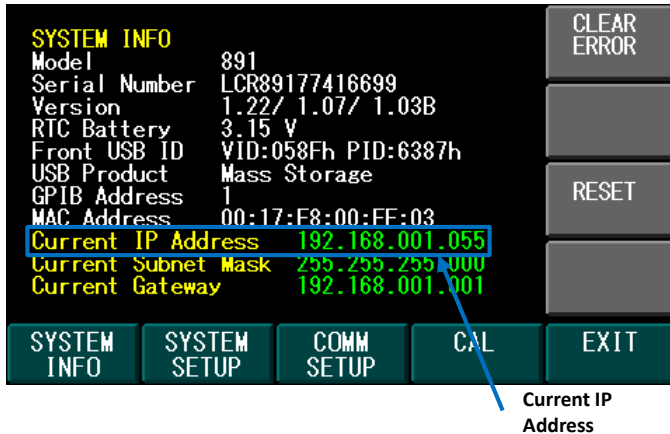

Figure 6.1 – Current IP Address

3. Type the IP address of the LCR meter in the URL bar of your browser with **http://** prefix (i.e. **http://192.168.1.55** for IP Address 192.168.1.55).
4. If correctly configured, the following screen will be shown:

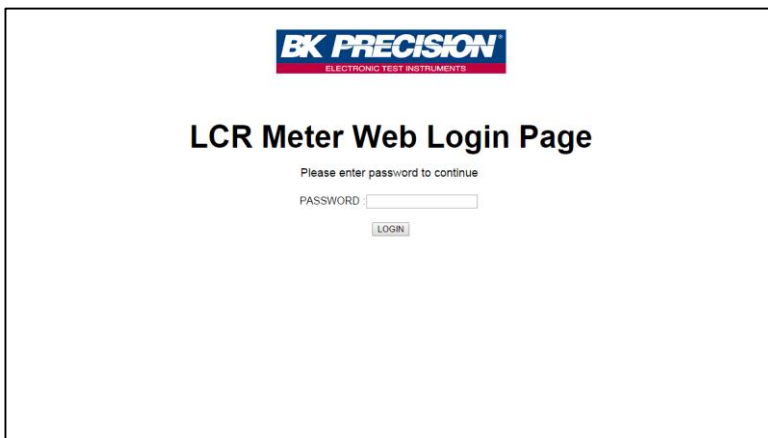

Figure 6.2 – Web Server Login Page

5. A password is required to login and access the menu items on the page. The default admin password is **123456**.

The web server menu items are described below:

- *HOME*

The HOME page provides general information of the LCR meter: Model Number, Manufacturer, Firmware version, Front USB ID/product, MAC address, and IP address.

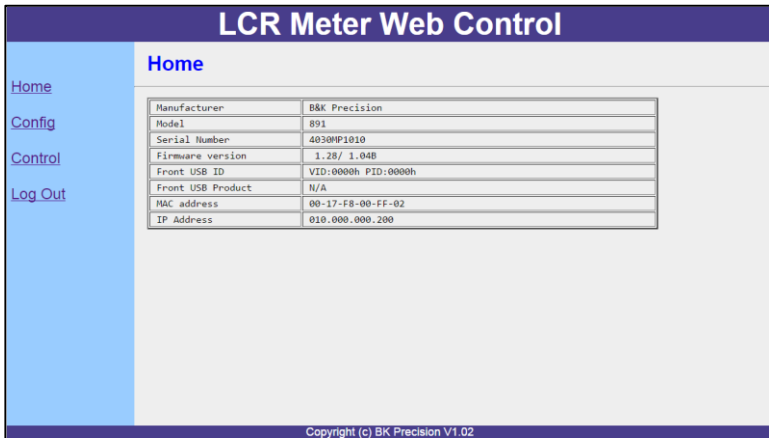

Figure 6.3 – Web Server Home Page

- *CONFIG*

The CONFIG page provides the setting of date, time, and brightness.

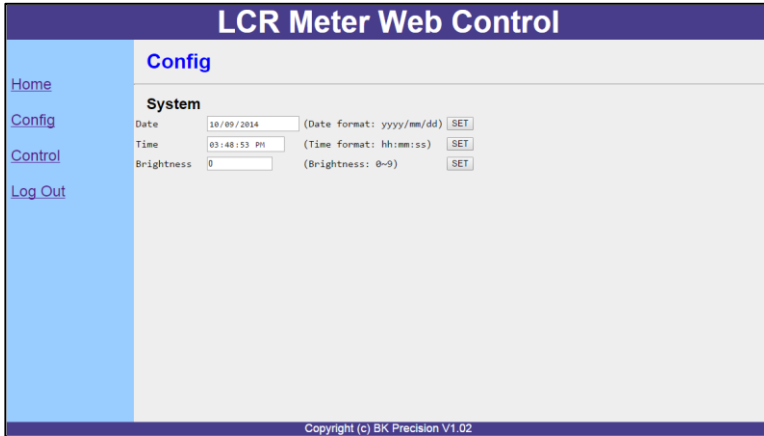

Figure 6.4 – Web Server Configuration Page

- *CONTROL*

The CONTROL page provides the general control of the LCR meter such as measurement function, test frequency, test level, range, and speed. The real time measurement result is shown on this page. The command line to send and receive SCPI commands can also be accessed here.

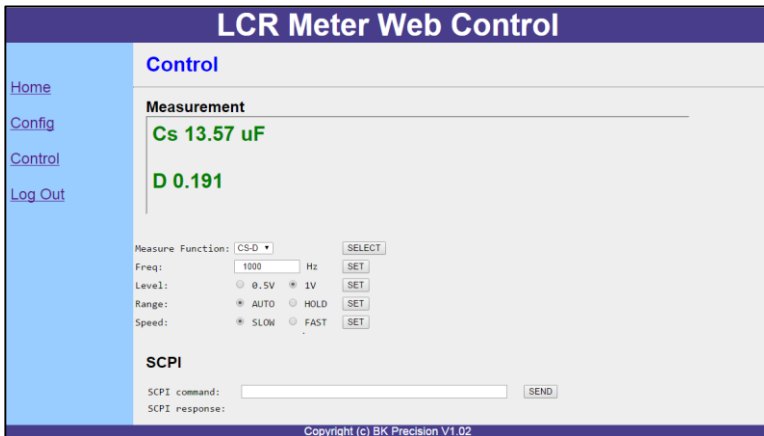

Figure 6.5 – Web Server Control Page

Log Out will exit the web page and go back to the login screen.

Telnet Connection

The instrument can be connected via LAN (Ethernet) interface using Telnet client with the following socket port **5024**.

Socket Connection

Socket connection is available for communication via LAN (Ethernet) interface. Users can use socket port **5025** to open a raw socket connection for sending remote commands.

Note: The TCP protocols are used to communicate with the instrument.

Note: When controlling the instrument via LAN, the instrument needs to have additional delays of at least 100 ms added between each write operations to ensure a stable connection between the computer and the instrument.

6.2 Parameter Definition

The instrument supports communication protocols, which include standard SCPI commands and a few proprietary commands that follow the SCPI convention. This enables users to operate the LCR meter through a computer or a terminal equipped with IEEE-488.2 GPIB, USB, or LAN interface. Additionally, it allows remote control and monitoring. SCPI IEEE-488.2 also supports multi-unit control allowing a user to control up to 30 units.

Note: GPIB and LAN interface have an internal buffer of 100 bytes. If multiple commands of the same subsystem are sent in one string, note this buffer size will limit how many commands can be sent at once.

The following table lists all of the numeric parameters.

Table 6.1 – SCPI Numeric Parameters

Symbol	Response Formats
<bool>	Boolean value, can be 1 or “ON”, 0 or “OFF”

<NR1>	Integer value, can be zero, positive or negative integer number
<NRf>	Flexible numerical value, can be zero, positive or negative float point numeric value
<string>	String value, characters enclosed in single or double quotes
<NL>	New line, hex code 0x0Ah
<Rtn>	Return, hex code 0x0Dh

All commands should be ended with the <Rtn> and <NL> and there should be a space between command and numeric parameter.

6.3 Error/Event List

SCPI can offer an error/event list that contains up to 10 errors/events. Users can read the list through the "SYStem:ERRor?" command in a first-in first-out manner. Once an error or event is read, the read process will clear it from the memory. To clear all errors or events from the memory, the "*CLS" command can be used.

The following table lists all the known errors that can be encountered.

Table 6.2 – Error List

Error	Description
-000	No error
-102	Syntax error
-103	Invalid separator
-108	Parameter not allowed
-109	Missing Parameter
-113	Undefined header
-131	Invalid suffix
-138	Suffix not allowed
-200	Execution error

6.4 SCPI Common Commands

The instrument is compatible with most of the common IEEE-488.2 and SCPI commands. Common commands generally control overall LCR meter functions, such as reset, status, and synchronization. All common commands consist of a three-letter mnemonic preceded by an asterisk (*). Commands ended with question mark (?) represent a query command.

The following table lists the common SCPI commands supported:

Table 6.3 – SCPI Common Commands List

Command	Description
*CLS	Clear status
*IDN?	Return the instrument identification (<Manufacturer>, <model>, <serial number>, <firmware type and version>)
*RCL <NR1>	Recall setting from memory
*RST	Reset
*SAV <NR1>	Save setting to memory

6.5 SCPI Command Subsystem

Subsystem commands are specific to functions. They can be a single command or a group of commands. The groups are comprised of commands that extend one or more levels below the root. The subsystem commands are arranged alphabetically according to the function they perform.

The following table lists the common SCPI subsystem commands supported:

Table 6.4 – SCPI Command Subsystem

Command	Description
CALibrate	Calibrate subsystem
:BUSY?	Return calibration status <NR1>, 0=done, 1=busy, -1=fail

:OPEN	Execute open calibration
:SHORT	Execute short calibration
BIN	BIN subsystem
:ABSolute	Absolute mode
:COMPARator	
:BIN[1-9] <BOOL ?>	Set or return the bin[1-9] comparator on or off switch
:SECondary <BOOL ?>	Set or return the secondary bin comparator on or off
:COUNT	
:CLEar	Clear bin counts
:DATA?	Return the bin counts of bin 1<NR1>, bin 2 <NR1>, ..., bin 9 <NR1>, out of specification bin <NR1> and secondary bin <NR1>
:LIMit	
:BIN[1-9] <NRf, NRf ?>	Set or return the limit value of the bin[1-9], <NRf, NRf> = <low, high>
:SECondary <NRf, NRf ?>	Set or return the limit value of secondary bin <NRf, NRf> = <low, high>
:BEEPer <OFF/0 PASS/1 FAIL/2 ?>	Set or return the beeper in bin test
:DISPlay	
:MODE <BIN/0 TABLE/1 HISTogram/2 ?>	Set or return display mode of bin test
:BIN <CSQ/0 CSD/1 CSR/2 CPQ/3 CPD/4 CPR/5 CPG/6 LSQ/7 LSD/8 LSR/9 LPQ/10 LPD/11 LPR/12 LPG/13 ZTH/14 YTH/15 RX/16 GB/17 DCR/18 ?>	Set or return function in BIN display mode

<pre>:TABLE <CSQ/0 CSD/1 CSR/2 CPQ/3 CPD/4 CPR/5 CPG/6 LSQ/7 LSD/8 LSR/9 LPQ/10 LPD/11 LPR/12 LPG/13 ZTH/14 YTH/15 RX/16 GB/17 DCR/18 ?></pre>	<p>Set or return function in BIN table display mode</p>
<pre>:HISTogram <CSQ/0 CSD/1 CSR/2 CPQ/3 CPD/4 CPR/5 CPG/6 LSQ/7 LSD/8 LSR/9 LPQ/10 LPD/11 LPR/12 LPG/13 ZTH/14 YTH/15 RX/16 GB/17 DCR/18 ?></pre>	<p>Set or return function in BIN histogram display mode</p>
<pre>:MODE <ABSolute/0 TOLerance/1 ?></pre>	<p>Set or return the bin count mode</p>
<pre>:START <BOOL ?></pre>	<p>Set or return the BIN start running status</p>
<pre>:SWAP <BOOL ?></pre>	<p>Set or return the BIN primary and secondary swap parameter</p>
<pre>:TOLerance</pre>	
<pre>:COMParator :BIN[1-9] <BOOL ?></pre>	<p>Set or return the bin[1-9] comparator on or off</p>
<pre>:SECondary <BOOL ?></pre>	<p>Set or return the secondary bin comparator on or off</p>
<pre>:COUNT</pre>	
<pre>:CLEar</pre>	<p>Clear bin counts</p>

:DATA?	Return the bin counts of bin 1<NR1>, bin 2 <NR1>, ..., bin 9 <NR1>, out of specification bin <NR1> and secondary bin <NR1>
:LIMit :BIN[1-9] <NRf, NRf ?>	Set or return the limit value of the bin[1-9], <NRf, NRf> = <low, high>
:SECondary <NRf, NRf ?>	Set or return the limit value of secondary bin <NRf, NRf> = <low, high>
:NOMinal <NRf ?>	Set or return the nominal value of tolerance mode
:TRIGger	Trigger a measurement of bin count
DISPlay :FONT <NORMAL/0 LARGE/1 ?>	Display subsystem Set or return display font
:MODE <DECimal/0 SCientific/1 ?>	Set or return display mode
:PAGE < BIN/0 MEASurement/1 SWEEp/2 SYSTem/3 ?>	Select or return measurement function page
:PRImary:DIGit <NR1 ?>	Set or return primary digits
:SECondary:DIGit <NR1 ?>	Set or return secondary digits
FETCh?	Return the fetched (display) primary <NRf> and secondary <NRf> reading
FORMat [:DATA] <ASCIi/0 REAL/1 ?>	Format subsystem Select or return the data format to be ASCII code or binary code
FREQuency <NRf ?>	Set or return test signal frequency
LEVel :AC <NRf ?>	Level subsystem Set or return test signal level (0.5 or 1)
MEASurement :FUNCTion < CSQ/0 CSD/1 CSR/2 CPQ/3 CPD/4 CPR/5 CPG/6 LSQ/7	Measurement subsystem Set or return the measurement function

<p>LSD/8 LSR/9 LPQ/10 LPD/11 LPR/12 LPG/13 ZTH/14 YTH/15 RX/16 GB/17 DCR/18 ?></p> <p>:RANGe < HOLD/0 AUTO/1 ?></p> <p>RESULT?</p> <p>:SPEEd <SLOW/1 FAST/2 ?></p>	<p>Set or return the measurement range control</p> <p>Return the measured (raw data) primary <NRf> and secondary <NRf> reading</p> <p>Set or return the measurement speed</p>
<p>RECall</p> <p>:CONFIguration <NR1></p>	<p>Recall subsystem</p> <p>Recall configuration parameters from internal memory (CFG00.CFG-CFG09.CFG) or external USB flash disk (CFG10.CFG-CFG99.CFG)</p>
<p>SWEEp</p> <p>:BUSY?</p> <p>:POInt <NR1 ?></p> <p>:DATA?</p> <p>:DATA: ALL?</p> <p>:MODE <LINear/0 LOGarithm/1 ?></p> <p>:DISPlay</p>	<p>Sweep subsystem</p> <p>Queries the status of sweep.</p> <p>Set or return the sweep point n to be returned the result of SWEEp:DATA? command</p> <p>Return sweep test results of the frequency <NRf> and data <NRf> of point n</p> <p>Return sweep test results (300 points) (This command is not supported via GPIB and LAN interface due to buffer size limit.)</p> <p>Set or return the sweep mode</p>

:LIMit <NRf, NRf ?>	Set or return the sweep display limits <low, high>
:MODE <GRAPh/0 TABLE/1 ?>	Set or return the sweep display mode
:LINear	
:GRAPh <CSQ/0 CSD/1 CSR/2 CPQ/3 CPD/4 CPR/5 CPG/6 LSQ/7 LSD/8 LSR/9 LPQ/10 LPD/11 LPR/12 LPG/13 ZTH/14 YTH/15 RX/16 GB/17 ?>	Set or return function in sweep linear graph mode
:TABLE <CSQ/0 CSD/1 CSR/2 CPQ/3 CPD/4 CPR/5 CPG/6 LSQ/7 LSD/8 LSR/9 LPQ/10 LPD/11 LPR/12 LPG/13 ZTH/14 YTH/15 RX/16 GB/17 ?>	Set or return function in sweep linear table mode
:LOGarithm	
:GRAPh <CSQ/0 CSD/1 CSR/2 CPQ/3 CPD/4 CPR/5 CPG/6 LSQ/7 LSD/8 LSR/9 LPQ/10 LPD/11 LPR/12 LPG/13 ZTH/14 YTH/15	Set or return function in sweep linear graph mode

<pre> RX/16 GB/17 ?> :TABLE CSQ/0 CSD/1 CSR/2 CPQ/3 CPD/4 CPR/5 CPG/6 LSQ/7 LSD/8 LSR/9 LPQ/10 LPD/11 LPR/12 LPG/13 ZTH/14 YTH/15 RX/16 GB/17 ?> :FREQuency :START <NRf ?> :STOP <NRf ?> :STEP <NR1 ?> :START <BOOL > :SWAP <BOOL ?> :BUSY? :CLEAr :AUTO :SCALE <BOOL ?> :FREQ <BOOL ?> :INTERPolate <BOOL ?> </pre>	<pre> Set or return function in sweep log table mode Set or return sweep start frequency Set or return sweep stop frequency Set or return sweep steps Set or return sweep start running status Set or return the sweep primary and secondary swap parameter Return sweep running status Clear sweep data from memory Set or return sweep auto scale status Set or return sweep auto frequency status Set or return data interpolation. This must be enable or disabled before running a sweep. Data loss will occur if changed after a sweep. </pre>
<pre> SAVe :CONFIg <NR1> </pre>	<pre> Save subsystem Save configuration parameters to internal memory (CFG00.CFG-CFG09.CFG) or external USB flash disk (CFG10.CFG- CFG99.CFG) </pre>

:MEASurement <NR1> :SCReen <NR1>	Save measurement result to external USB flash disk (RLT00.TXT-RLT99.TXT) Save screen to external USB flash disk (SCR000.BMP-SCR999.BMP)
SYStem :DATE <NR1, NR1, NR1 ?> :BEEPer <Bool ?> :BRIGHtness <NR1 ?> :ERRor? :GPIB :ADDRess <NR1 ?> :IP :ADDRess <NR1.NR1. NR1.NR1 ?> :CONFIg <STATic MANUal/0, DHCP AUTO/1 ?> :GATEway <NR1.NR1. NR1.NR1 ?> :MASK <NR1.NR1.NR1. NR1 ?> :TIME <NR1, NR1, NR1 ?>	System subsystem Set or return current date <year, month, day> Set or return beeper state Set or return display brightness status return system error Set or return GPIB address value Set or return Ethernet IP address Set or return Ethernet IP mode Set or return ethernet IP gateway Set or return ethernet IP mask Set or return current time <hour, minute, second>

7 Troubleshooting Guide

Below are some frequently asked questions and answers. Please check if any apply to your instrument before contacting B&K Precision.

Q: I cannot power up the instrument

- Check that the power cord is securely connected to the AC input and there is live power from your electrical AC outlet.
- Check and confirm that the correct fuse is inserted and not blown.
- Verify that the AC power coming from the mains is the correct voltage. The generator can accept a specific range of AC input voltages. Refer to section “2.1 Input Power Requirements”.

Q: The measurements on the instrument are shown in a different color

- The component under test may be out of the range of the LCR meter. Please see the specifications and ranges of the unit.
- Make sure the component test fixture or Kelvin clip is properly secured to the unit and perform an open and short calibration.

Q: The front panel keys are not responding to key presses

- Verify that the instrument is in REMOTE mode (RMT will be shown on the front panel in green.) If it is in REMOTE mode, the unit must be changed to LOCAL mode in order to respond to front panel key presses. To return to LOCAL mode from the front panel, press the  key.

8 Specifications

Note: All specifications apply to the unit after a temperature stabilization time of 15 minutes over an ambient temperature range of $23\text{ }^{\circ}\text{C} \pm 5\text{ }^{\circ}\text{C}$. Specifications are subject to change without notice.

Basic Measurement Function

Measurements	Series mode		Parallel mode	
	Primary	Secondary	Primary	Secondary
Capacitance	Cs	Q, D, Rs	Cp	Q, D, Rp, G
Inductance	Ls	Q, D, Rs	Lp	Q, D, Rp, G
Resistance	R	X		
Conductance			G	B
Impedance	Z	θ		
Admittance			Y	θ
DC Resistance	DCR			

Enhanced Measurement Function	
Bin Sort Comparator	
Limit setting mode	Tolerance (TOL) or Absolute (ABS) value
Number of bins	9 Primary, 1 Secondary, 1 Out of Spec
Bin counts	0 to 60000
Beep warning	OFF, Pass with smart tone, and Fail
Trigger	Manual Trigger
Display format	Measurement, Table, and Histogram
Sweep	
Frequency range	20.00 Hz to 300.0 kHz
Sweep modes	Linear and Logarithmic
Sweep points	Up to 300 points
Sweep step	1, 2, 5, and 10 points/step
Parameters	Primary and Secondary
Display format	Graph and Table

Parameter Display Range	
Cs, Cp	0.000 F to \pm 9999 F
Ls, Lp	0.000 H to \pm 9999 H
Rs, Rp, R, Z	0.000 Ω to \pm 9.999 G Ω
G, B, Y	0.000 S to \pm 9.999 GS
D	0.000 to \pm 9999
Q	0.000 to \pm 9999
θ	0.000 $^{\circ}$ to \pm 180.00 $^{\circ}$
DCR	0.000 Ω to \pm 9.999 G Ω

Test Signal	
Frequency	20 Hz to 300 kHz
Resolution	0.01 Hz (20.00 Hz to 99.99 Hz) 0.1 Hz (100.0 Hz to 999.9 Hz) 1 Hz (1.000 kHz to 9.999 kHz) 10 Hz (10.00 kHz to 99.99 kHz) 100 Hz (100.0 kHz to 300.0 kHz)
Accuracy	\pm 0.1%

Test Signal Level	
AC Level	
Range	0.5 Vrms and 1 Vrms selectable
Accuracy	5%
Output impedance	100 Ω (nominal)
DC Level	
Range	1 VDC
Accuracy	5%
Output impedance	100 Ω (nominal)

Measurement Accuracy

Best accuracy : 0.05%

Impedance (Z) Accuracy: Z_{ae}

Frequency Impedance	DC, 20 Hz – 1 kHz	1 kHz – 10 kHz	10 kHz – 100 kHz	100 kHz – 200 kHz	200 kHz – 300 kHz
0.1 Ω – 1 Ω	1% ± 1	1% ± 1	2% ± 1	5% ± 1	10% ± 1
1 Ω – 100 Ω	0.5% ± 1	0.5% ± 1	1% ± 1	2% ± 1	4% ± 1
100 Ω – 1 kΩ	0.2% ± 1	0.2% ± 1	0.2% ± 1	0.5% ± 1	1% ± 1
1 kΩ – 10 kΩ	0.05% ± 1	0.2% ± 1	0.5% ± 1	1% ± 1	2% ± 1
10 kΩ – 100 kΩ	0.2% ± 1	0.2% ± 1	0.5% ± 1	1% ± 1	2% ± 1
100 kΩ – 1 MΩ	0.5% ± 1	0.5% ± 1	2% ± 1	2% ± 1	4% ± 1
1 MΩ – 10 MΩ	1% ± 1	2% ± 1	5% ± 1	5% ± 1	10% ± 1
10 MΩ – 20 MΩ	4% ± 1	5% ± 1	--	--	--

Accuracy is based on test signal level at 1 VRMS, slow measurement speed

A_e multiply 1.1 at 0.5 VRMS test signal level

1. Capacitance (C) Accuracy: C_{ae}

Refer to - Measurement Accuracy Chart for C_{ae}

when $Dx \leq 0.1$, C_{ae}

when $Dx > 0.1$, $C_{ae} \times \sqrt{1 + Dx^2}$

Dx : Measured D value

C_{ae} : Relative Accuracy of C

2. Inductance (L) Accuracy: L_{ae}

Refer to - Measurement Accuracy Chart for L_{ae}

when $Dx \leq 0.1$, L_{ae}

when $Dx > 0.1$, $L_{ae} \times \sqrt{1 + Dx^2}$

Dx: Measured D value
Lae: Relative Accuracy of L

3. Resistance (R) Accuracy: Rae
Refer to - *Measurement Accuracy* Chart for Zae
Rae: $Xx \times Zae$

Xx: Measured X value
Zae: Relative Accuracy of Z

4. Conductance (G) Accuracy: Gae
Refer to - *Measurement Accuracy* Chart for Zae
when $Qx \leq 0.1$, Zae
when $Qx > 0.1$, $Zae \times (1 + Qx)$

Qx: Measured Q value
Zae: Relative Accuracy of Z

5. Admittance (Y) Accuracy: Yae
Refer to - *Measurement Accuracy* Chart for Zae
Yae: Zae

6. Dissipation factor (D) Accuracy: Dae
Refer to - *Measurement Accuracy* Chart for Zae
when $Dx \leq 0.1$, Zae
when $Dx > 0.1$, $Zae \times (1 + Dx^2)$

Dx: Measured D value
Zae: Relative Accuracy of Z

Example:

Frequency: 1 kHz; Level: 1 VRMS; Measured Cx Value: 15 μ F; Dx: 0.122

Step 1: Find C_{ae} ; Refer to - *Measurement Accuracy Chart*

$C_{ae} = Z_{ae} = \pm 0.5\%$

Step 2: Find D_{ae} ; $Dx > 0.1$

$Z_{ae} \times (1 + Dx^2) = 0.005 \times (1 + 0.122^2) = 0.005074 = \pm 0.5074\%$

7. Quality factor (Q) Accuracy: Q_{ae}

Refer to - *Measurement Accuracy Chart* for Z_{ae}

when $Qx \times D_{ae} \geq 1$, Z_{ae}

when $Qx \times D_{ae} < 1$, $\pm \frac{Qx^2 \times D_{ae}}{1 \mp Qx \times D_{ae}}$

Qx : Measured Q value

D_{ae} : Relative Accuracy of D

Z_{ae} : Relative Accuracy of Z

Example:

Frequency: 500 Hz; Level: 0.5 VRMS; Measured Lx Value: 1013 mH; Qx : 10.18;
 Dx : 0.098

Step 1: Find L_{ae} ; Refer to - *Measurement Accuracy Chart*

A_e multiply 1.1 at 0.5 VRMS; $Z_{ae} \times 1.1 = L_{ae} = D_{ae} = \pm 0.05\% \times 1.1 = \pm 0.055\%$

Step 2: Find $Qx \times D_{ae}$; $10.18 \times 0.00055 = 0.005599$; $Qx \times D_{ae} < 1$

Step 3: Find Q_{ae} ; $\pm \frac{Qx^2 \times D_{ae}}{1 \mp Qx \times D_{ae}} = \pm \frac{.05699}{1 \mp 0.00509}$

8. Susceptance (B) Accuracy: B_{ae}

Refer to - *Measurement Accuracy Chart* for Z_{ae}

when $Qx \leq 0.1$, Z_{ae}

when $Qx > 0.1$, $Z_{ae} \times (1 + Qx)$

Qx : Measured Q value

Z_{ae} : Relative Accuracy of Z

9. Phase Angle (θ) Accuracy: θ_{ae}

Refer to - *Measurement Accuracy Chart* for Z_{ae}

$$\theta_{ae} = \pm \frac{180}{\pi} \times Z_{ae}$$

Z_{ae} : Relative Accuracy of Z

Example:

Frequency: 500 Hz; Level: 1 VRMS; Measured Lx Value: 100 μ H

Step 1: Find L_{ae} ; Refer to - *Measurement Accuracy Chart*

$L_{ae} = Z_{ae} = \pm 1\%$

Step 2: Find θ_{ae} ; $\pm \frac{180}{\pi} \times Z_{ae} = \pm \frac{180}{\pi} \times 0.01 = \pm 0.573^\circ$

Note: If calculated $\theta_{ae} \leq 0.1^\circ$, $\theta_{ae} = 0.1^\circ$

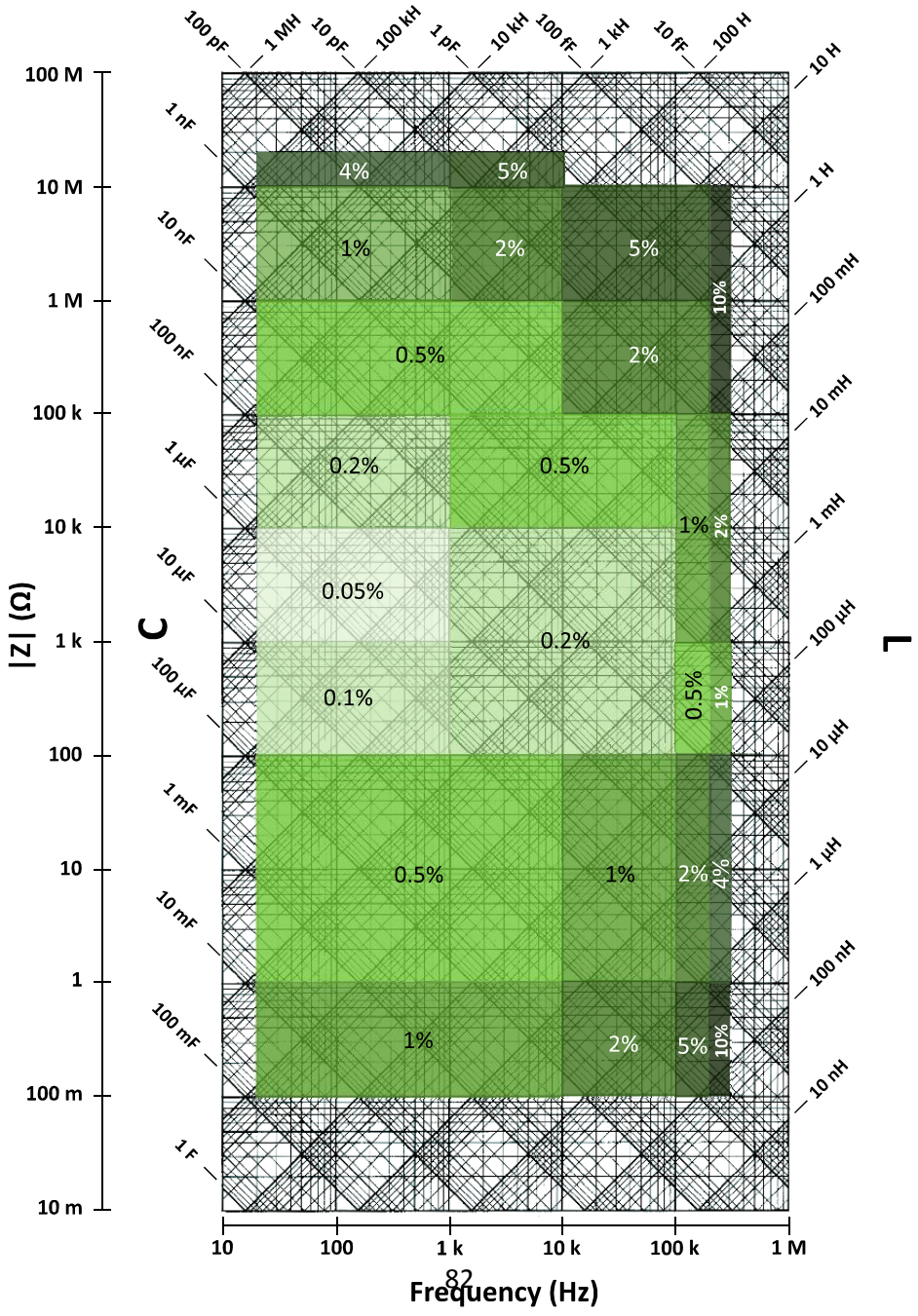

Figure 8.1 - Measurement Accuracy Chart

Measurement Speed	
Slow	800 ms/measurement
Fast	200 ms/measurement
Measurement Range	
Range	Auto or Hold range

Save/Recall	
Instrument Settings	
Locations	number 00 – 09 at internal storage number 10 – 99 at external USB storage
Measurement results and screenshots	
Locations	number 000 – 999 at external USB storage

General	
Remote Interface	USB (Virtual COM), GPIB, Ethernet
Display	4.3" 480 × 272 LCD display
AC Input	104 V - 126 V, 50/60 Hz 207 V - 253 V, 50/60 Hz
Power Consumption	20 VA max.
Operating Temperature	0 °C to 40 °C
Storage Temperature	-10 °C to 70 °C
Relative Humidity	up to 80%
Dimension (W×H×D)	258 × 113 × 381 mm
Weight	3.4 kg

To ensure the most current version of this manual, please download the latest version here: bkprecision.com/search/891

For current up-to-date product information, please visit bkprecision.com

SERVICE INFORMATION

Warranty Service: Please go to the support and service section on our website at bkprecision.com to obtain a RMA #. Return the product in the original packaging with proof of purchase to the address below. Clearly state on the RMA the performance problem and return any leads, probes, connectors and accessories that you are using with the device.

Non-Warranty Service: Please go to the support and service section on our website at bkprecision.com to obtain a RMA #. Return the product in the original packaging to the address below. Clearly state on the RMA the performance problem and return any leads, probes, connectors and accessories that you are using with the device. Customers not on an open account must include payment in the form of a money order or credit card. For the most current repair charges please refer to the service and support section on our website.

Return all merchandise to B&K Precision Corp. with prepaid shipping. The flat-rate repair charge for Non-Warranty Service does not include return shipping. Return shipping to locations in North America is included for Warranty Service. For overnight shipments and non-North American shipping fees please contact B&K Precision Corp.

B&K Precision Corp.
22820 Savi Ranch Parkway
Yorba Linda, CA 92887
bkprecision.com
714-921-9095

Include with the returned instrument your complete return shipping address, contact name, phone number and description of problem.

LIMITED THREE-YEAR WARRANTY

B&K Precision Corp. warrants to the original purchaser that its products and the component parts thereof, will be free from defects in workmanship and materials for a period of **three years** from date of purchase.

B&K Precision Corp. will, without charge, repair or replace, at its option, defective product or component parts. Returned product must be accompanied by proof of the purchase date in the form of a sales receipt.

To help us better serve you, please complete the warranty registration for your new instrument via our website bkprecision.com

Exclusions: This warranty does not apply in the event of misuse or abuse of the product or as a result of unauthorized alterations or repairs. The warranty is void if the serial number is altered, defaced or removed.

B&K Precision Corp. shall not be liable for any consequential damages, including without limitation damages resulting from loss of use. Some states do not allow limitations of incidental or consequential damages. So the above limitation or exclusion may not apply to you.

This warranty gives you specific rights and you may have other rights, which vary from state-to-state.

B&K Precision Corp.
22820 Savi Ranch Parkway
Yorba Linda, CA 92887
bkprecision.com
714-921-9095

BK PRECISION[®]

22820 Savi Ranch Parkway
Yorba Linda, CA 92887
bkprecision.com

© 2015 B&K Precision Corp.