

LANGER
EMV-Technik

User Manual

Development System - Disturbance Emission ESA1



Copyright (C) Dipl.-Ing. Gunter Langer
Nöthnitzer Hang 31
01728 Bannewitz
15.05.2002

Measuring disturbances emitted by a module –
comparative measurements at the developer's workplace

Contents:	Page
1 Measurement procedure	3
2 Description of the components	4
2.1 GP 23 ground plate	4
2.2 Z23 shielding tent	5
2.3 HFW 21 RF current transformer	7
2.4 HFA 21 RF bypass	8
2.5 Near-field probes	9
2.6 PA 203 preamplifier	9
2.7 Measurement set-up	10
3 Practical procedure	11
3.1 Measuring with ESA1	11
3.2 ChipScan-ESA software	11
3.3 Localization through global changes to the unit under test	13
3.4 Reason analysis with near field probes	14
3.5 Modification of the module	15
4 Measurement set-up variants	16
4.1 Measurement of the common-mode component	16
4.1.1 Unit under test with one cable terminal	16
4.1.2 Unit under test with several cable terminals	17
4.1.3 Unit under test with indispensable cables	17
4.1.4 Example: Measurements on a complex unit under test	18
4.1.5 External data lines	21
4.2 Measurement of the differential-mode component	22
5 Safety instructions	23
6 Warranty	24
7 Technical parameters	25
7.1 Near-field probes	25
7.2 HFW 21 RF current transformer:	27
7.3 HFA 21 RF bypass	28
7.4 GP 23 ground plate	28
7.5 Z23-1 shielding tent	28
7.6 PA 203 preamplifier	28
8 Scope of delivery	29
8.1 Content of the ESA1 case	31

1 Measurement procedure

The ESA1 is suitable for carrying out comparative measurements of disturbances emitted by modules directly at the developer's workplace. Since the effect of any changes to the module becomes evident immediately, the time needed to optimize the unit under test can be dramatically reduced.

Measuring with the ESA1 development system is based on the following considerations:

In most cases, it is not a component or conductor track of a unit under test that directly emits any disturbances, rather the entire metal system of the unit under test is excited through electric or magnetic coupling (i.e. in the near field). This metal system comprises the PCB itself and all connected cables and metal parts such as housings, shielding plates etc. in its immediate vicinity. The system in its entirety acts as an antenna and a source of emission. This excitation is roughly equivalent to the disturbances emitted by the unit under test. To determine this excitation, measure the exciting currents that flow, for instance, from a PCB to any cables connected.

The measurements are performed with a conductive ground plate to reduce any influences of the measurement set-up, cable positions and local fields. Inject all exciting currents through short capacitive coupling into the ground plate so that you have a small reproducible set-up (**Figure 1**).

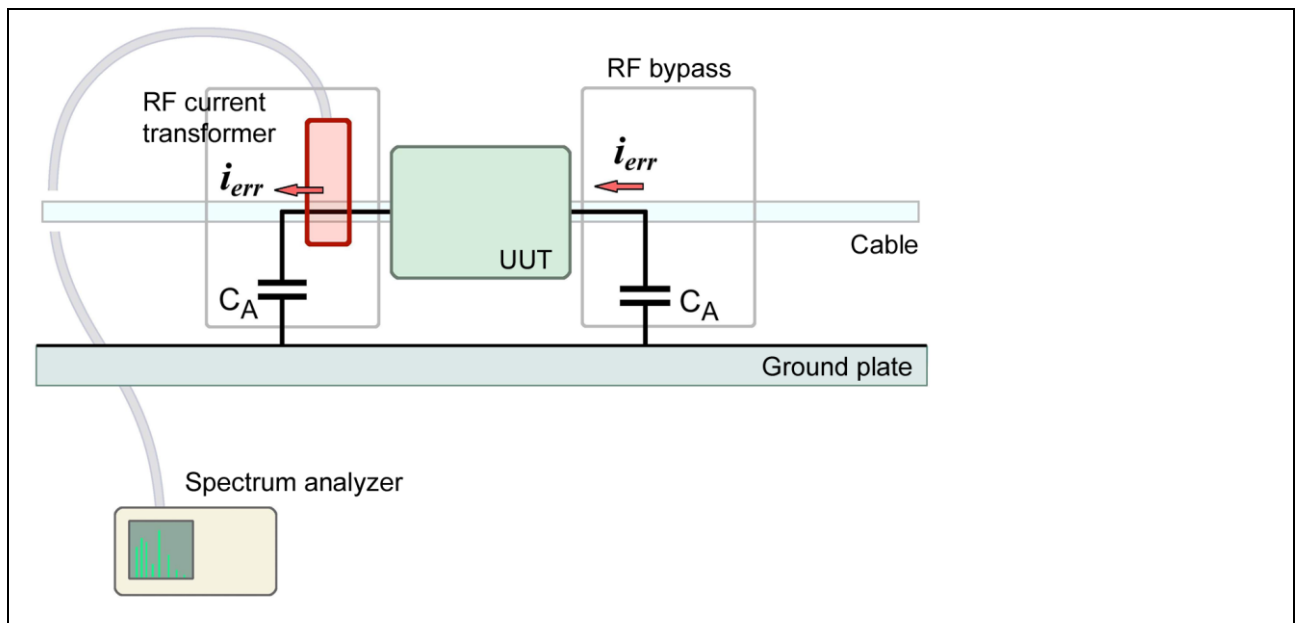

Figure 1

2 Description of the components

2.1 GP 23 ground plate

The GP 23 metal ground plate is the reference plane for the measurement set-up. It contains the connectors to supplying the unit under test and preamplifier as well as the output of the latter. (Figure 2).

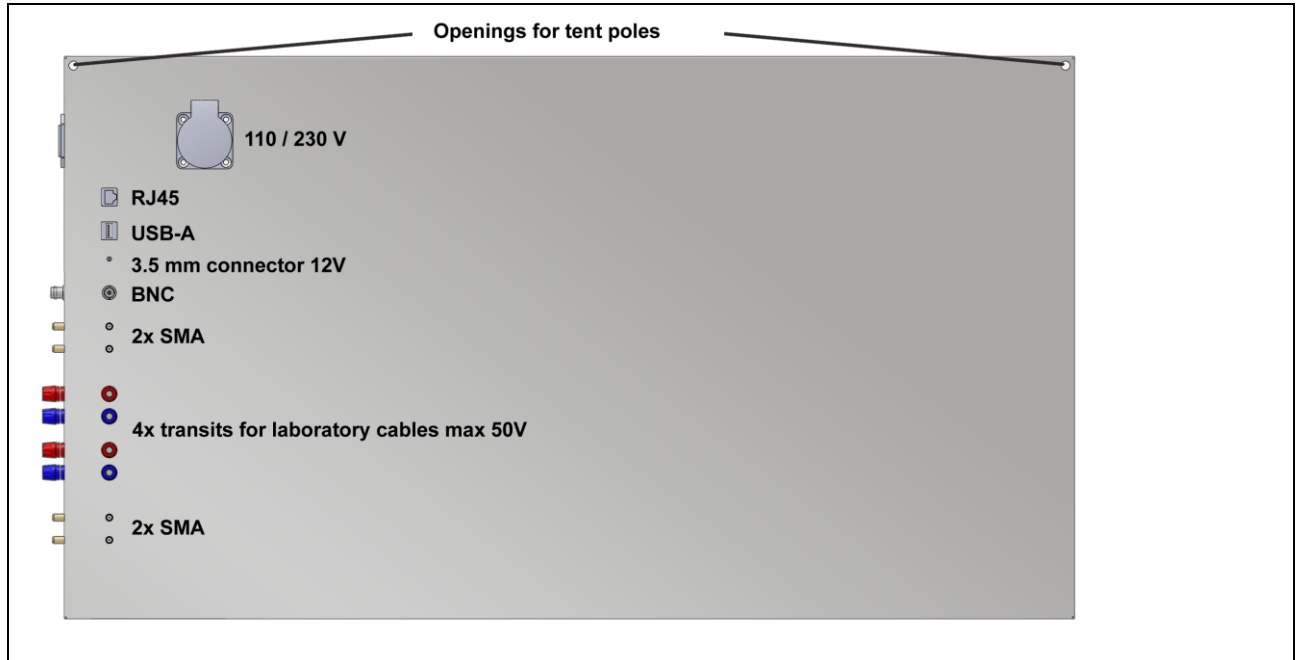

Figure 2 GP 23 Ground Plate

The nickel-plated surface ensures a steady and reliable conductive connection to the HFW 21 RF current transformer or HFA 21 RF bypass. Figure 3 shows the connections.

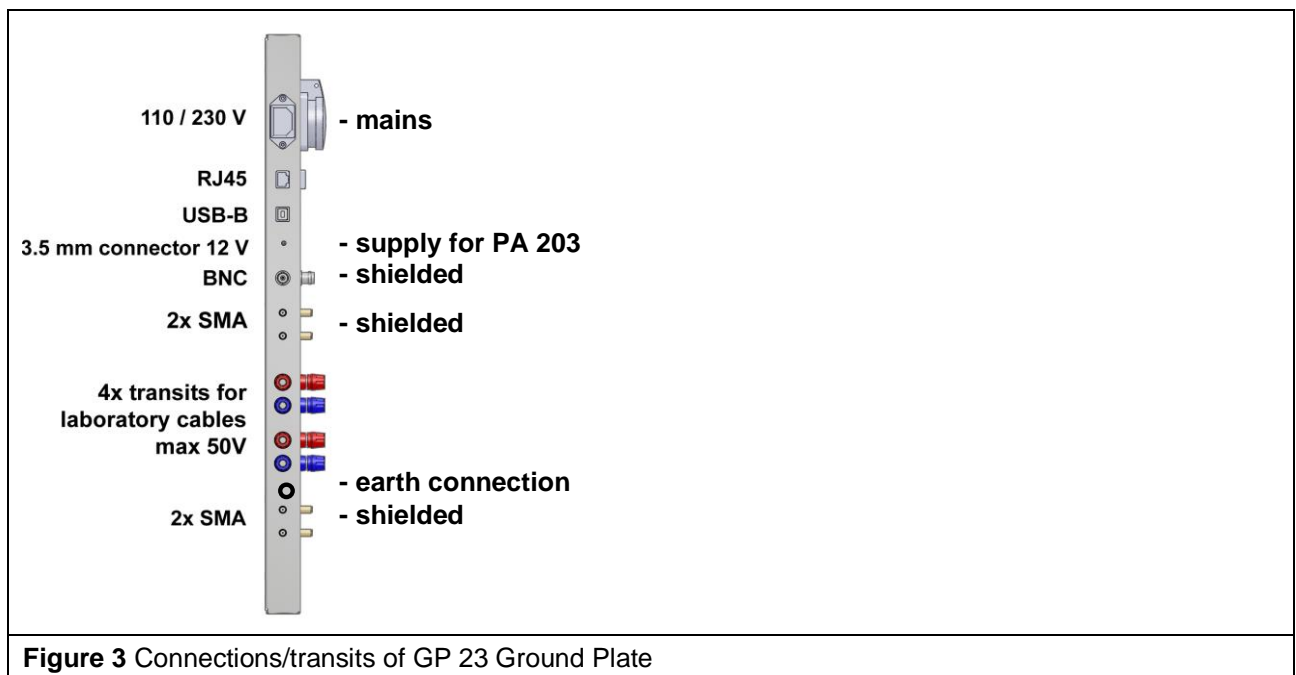

Figure 3 Connections/transits of GP 23 Ground Plate

The unit under test and the ground plate can be connected at any point via the HFA 21 RF bypass or with copper foil adhesive tape, for instance.

2.2 Z23-1 shielding tent

The shielding tent has been designed to shield the measurement set-up against external RF fields. In case of problems in the VHF range or particularly high demands on the unit under test as in the automobile industry, for instance, a conductive housing has to be used as a shield against ambient disturbance fields. Shielding in the immediate vicinity of the unit under test is possible because all cables to the unit under test are disconnected, coupled to the base plate through capacitive coupling or filtered in a typical ESA1 measurement set-up.

The tent poles are folded upon delivery for ease of transport. Two rubber plugs snap into place in the two rear openings of the ground plate to secure the tent against displacement (**Figure 4**).



Figure 4 ZG 23-1 tent poles folded (on GP 23 ground plate)

To put up the shielding tent, unfold the poles and insert them into the two rear openings of the ground plate (**Figure 5**).

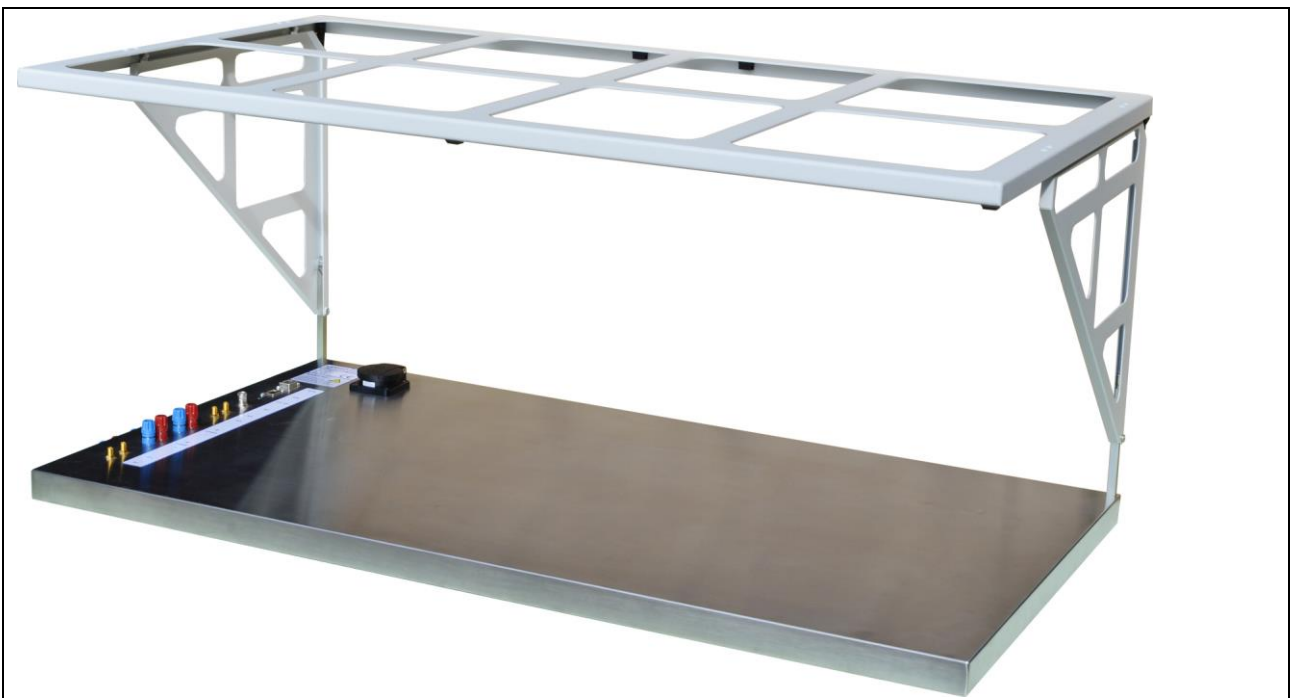

Figure 5 ZG 23-1 set up on the GP 23 ground plate

Then pull the BZ23-1 shielding material over the poles from the back. Flexible magnetic strips are attached to the edges of the shielding material. Press them against the edges of the ground plate to ensure a conductive connection. Two magnetic strips are provided for the connector area: one is fixed to the ground plate from the outside, the other one from the top. The front of the shielding material can be opened and closed separately to ensure quick alternation between measuring and modifying (**Figure 6 to Figure 8**).



After closing, press the lower edge of the front and the lower edge of the left and right side of the shielding material against the ground plate. An uninterrupted connection between the ground plate and shielding material is crucial for an effective shielding.

Figure 6 Z23-1 shielding tent closed



If the tent is set up as shown in **Figure 7**, you can see two press buttons at the upper front edge of the shielding material. Secure these around the front transverse bar.

Figure 7 Z23-1 shielding tent open



You can tilt the whole tent backward for ease of accessibility. The press buttons stop the shielding material from sliding down.

Figure 8 Z23-1 shielding tent tilted backwards

Attention! The shielding material is made from a thin, extremely conductive fabric. Protect the shielding material against high mechanical stress from sharp-edged or pointed objects, for example! Fold the shielding material in accordance with the folding instructions contained in the bag!

2.3 HFW 21 RF current transformer

The RF current transformer (Fehler! Verweisquelle konnte nicht gefunden werden. and) measures high-frequency currents of up to 1 GHz on lines and diverts these currents to the base plate.

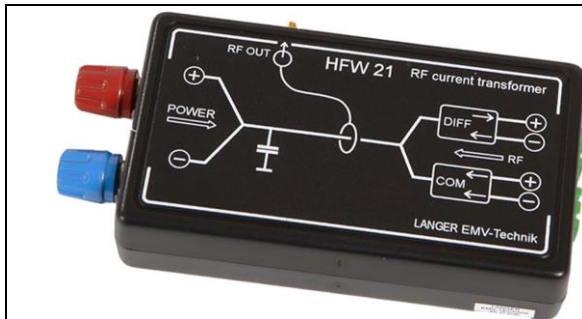

Figure 9 HFW 21 RF Current Transformer

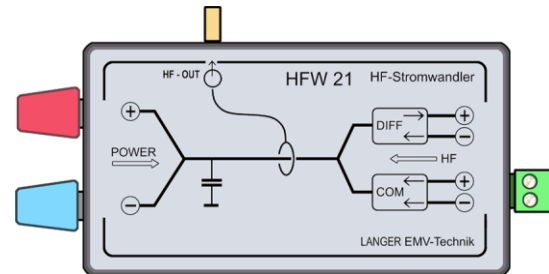

Figure 10 HFW 21 RF Current Transformer (schematic)

The RF current transformer enables separate measurements of RF common-mode and differential-mode currents. In practice, you can do this by connecting the RF current transformer into the power supply circuit of the unit under test, for example. The supply voltage is connected to the "POWER" socket connector of the current transformer via laboratory cable with a 4 mm plug and the unit under test is connected to the "COM" or "DIFF" output via one of the supplied plugs. The RF currents emitted by the unit under test are thus passed through the transformer, measured (output above the 50 Ohm SMB socket) and diverted to the metal transformer ground plate through capacitive coupling.

If the unit under test is connected via the "COM" output, the RF current transformer measures the common-mode currents flowing on both lines whereas the differential-mode currents are measured via the "DIFF" output.

The RF output voltage is independent of the direct current flowing through the transformer if common-mode measurements are carried out. In case of differential-mode measurements, the RF output voltage decreases according to the diagrams shown in section 7.

Please note:

A current surge occurs on switching on depending on how the unit under test is connected. If the electrolytic capacitors, for example, are charged without limiting the current and the unit under test is connected via the HFW 21 differential-mode output, there is a risk of damage to the preamplifier or spectrum analyzer input!

Always connect the HFW 21 to the PA 203 or spectrum analyzer after the unit under test has been switched on in such cases!

The same thing occurs during a short circuit in the unit under test if the electrolytic capacitors of the external power supply unit are abruptly discharged. There is no risk if the HFW 21 is operated via the common-mode output because these current pulses are compensated within the transformer.

Current peaks also occur if the supply of the unit under test is connected to earth and thus to the ground plate with an external power supply unit and the voltage in the unit under test is short-circuited to the GP 23 ground plate during the measurement:

2.4 HFA 21 RF bypass

The RF bypass (**Figure 11**) supplements the RF current transformer by providing another capacitive or conductive connection from the unit under test to the ground plate if necessary.

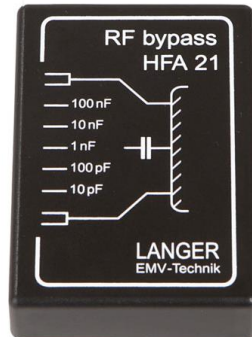

Figure 11 HFA 21 RF Bypass

It is mainly used to simulate the data lines connected in normal operation and their capacitance relative to the surroundings. Instead of the data line, a discrete capacitance is connected to the signal output via a measuring line within the HFA 21 (**Figure 12**). Alternative it is possible to connect each single signal step by step to the capacitance by a Probe tip (**Figure 13**). Defined RF currents can thus be diverted to the ground plate. The HFA 21 contains capacitances from 10 pF to 100 nF.

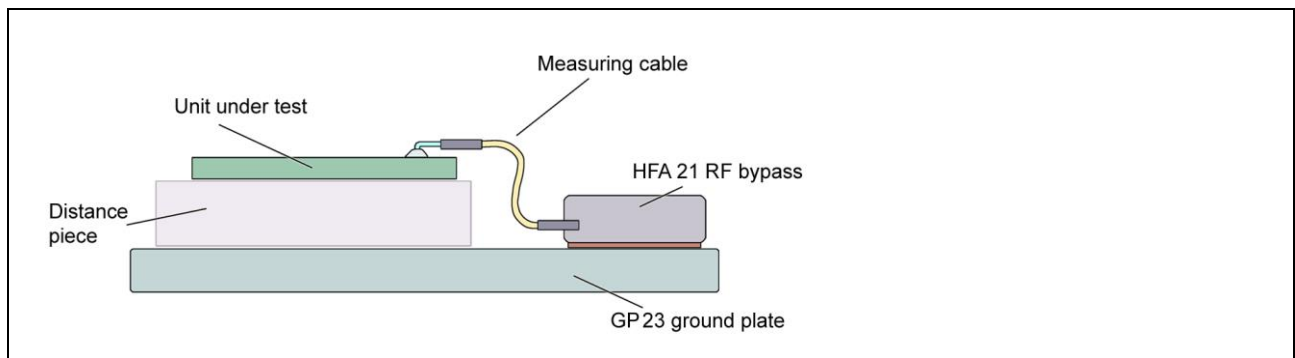

Figure 12

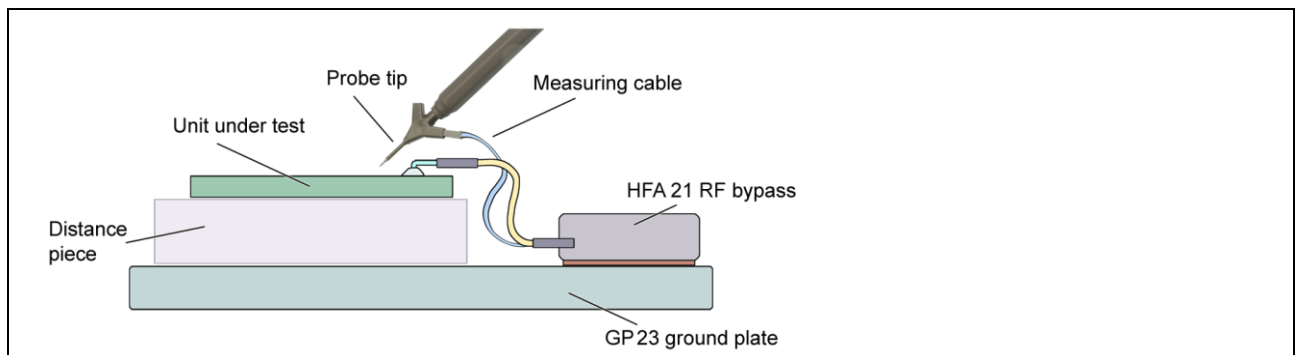

Figure 13

2.5 Near-field probes

Your ESA1 provides various near-field probes for measuring high-frequency magnetic and electric fields depending on its version. The probes are connected to the preamplifier instead of the HFW 21 and enable measurements in the area of the module, on tracks and components. The goal is to find the RF field sources on the module in the unit under test and to detect and understand the respective emission mechanisms. The developer can assess whether there are any RF fields that interfere with neighboring modules, structural parts or shields and cause disturbance emissions. In practical measurements the HFW 21 current transformer and the near-field probes are mostly used alternatively.

A wide range of probes is provided for the various measuring tasks:

The near-field probes of the RF type are suitable for measurements of magnetic and electrical fields in the frequency range between 30 MHz and 3 GHz. The probes differ with regard to the probe head's size and design so that you can always select the optimal probe for the measuring job. Please refer to the enclosed technical parameters (Section 7.1) for details about the precise pattern of the field measured by the probe and typical examples for application.

Optionally available:

The near-field probes of the LF type are available for measurements in the frequency range between 100 kHz and 50 MHz. They are particularly suitable in the areas of power supply, converters, drives etc. The RF current paths of individual switching transistors and free-wheeling diodes can be tracked and the respective magnetic fields measured, for example.

2.6 PA 203 preamplifier

The 20 dB preamplifier (**Figure 14**) operates in the frequency range between 100 kHz and 1 GHz and is suitable for measurements with the RF current transformer and near-field probes. The input and output are designed as 50 Ohm BNC plug-and-socket connectors and thus can be operated with any spectrum analyzer or oscilloscope.

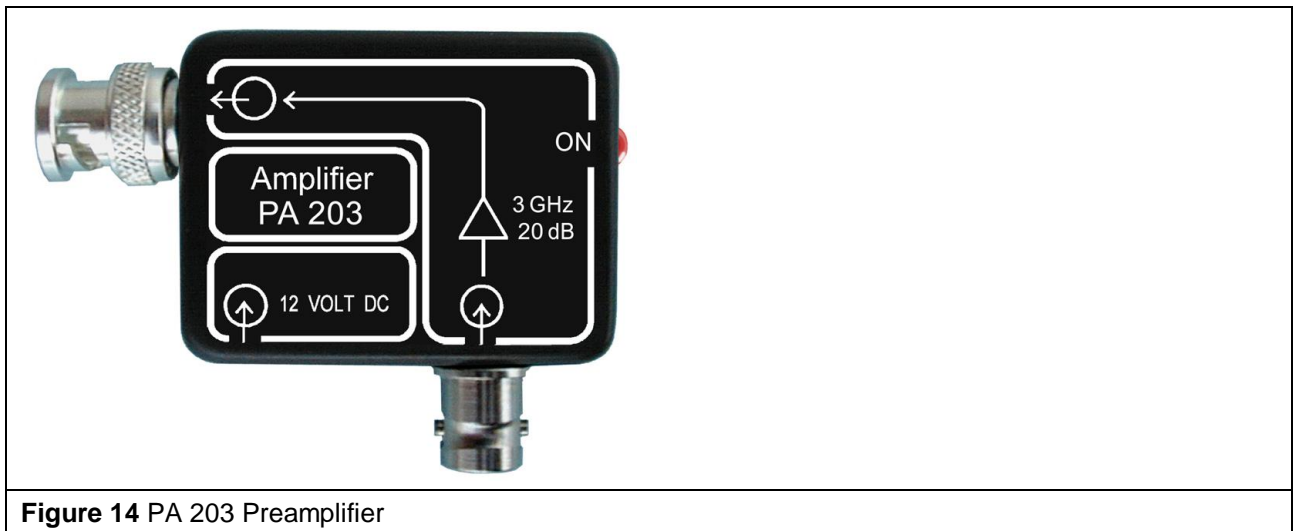

Figure 14 PA 203 Preamplifier

The preamplifier is operated inside the shielding tent during measurements with the ESA1 system (**Figure 15**). Filters are provided on the GP 23 ground plate for the preamplifier's output line and power supply. The output signal reaches the spectrum analyzer via the enclosed double-shielded BNC cable. Please use the enclosed plug-in power supply unit to supply power to the preamplifier. Saturation effects will occur if the input level at the preamplifier exceeds 60 dB μ V. In such a case, the HFW 21 RF current transformer or the near-field probe should be directly connected to the BNC socket connector on the ground plate without any preamplifier.

Please note:

There is a risk of destruction during HFW 21 operation when the differential-mode current is measured and electrolytic capacitors are switched on or a short circuit occurs!
In such cases always connect the HFW 21 to the PA 203 or spectrum analyzer only after the unit under test is switched on!

2.7 Measurement set-up

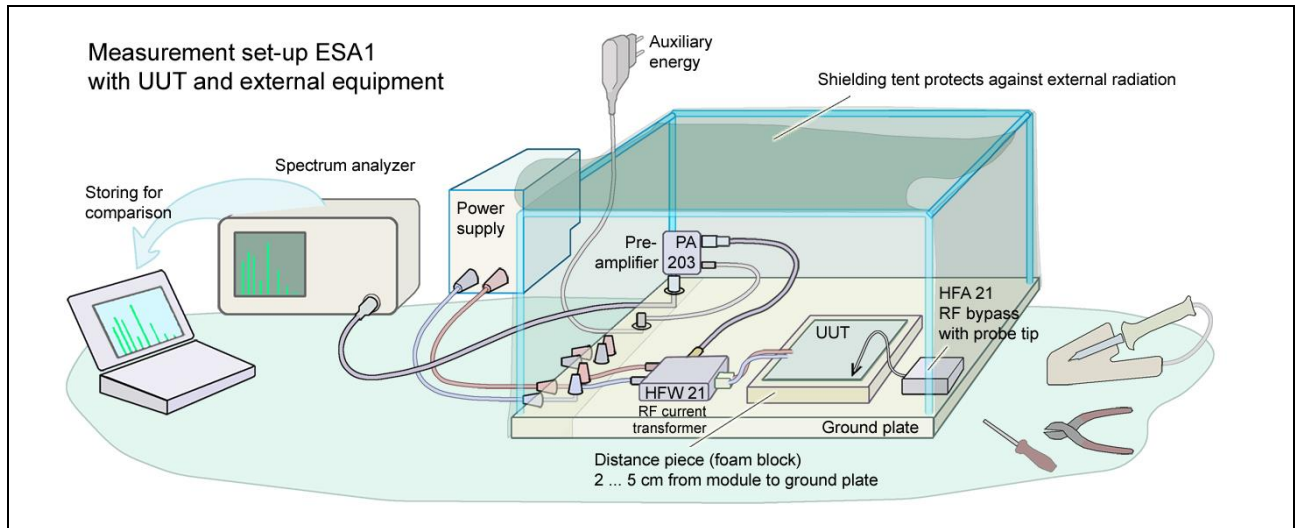

Figure 15 Measurement set-up ESA1 (schematic)

First place the GP 23 ground plate with its socket connectors pointing to the left (under normal conditions) and set up the shielding tent (description in section 2.2). Inside the shielding tent plug the PA 203 preamplifier into the BNC socket on the ground plate. Power is supplied via the enclosed plug-in power supply unit; outside the shielding tent plug the power supply unit into the 3.5 mm connector (next to the BNC socket) on the outer left side of the ground plate. Inside the shielding tent connect the 12 V input of the PA 203 to the 3.5 mm connector on the ground plate via the enclosed power supply cable (approx. 10 cm long, two power supply plugs). The "ON" LED on the PA 203 must come on. Then connect the HFW 21 RF current transformer or a near-field probe via the BNC-SMB connecting cable to the PA 203. Connect the spectrum analyzer to the BNC socket on the outer left edge of the ground plate via the enclosed BNC cable (double-shielded).

3 Practical procedure

3.1 Measuring with ESA1

The measurements carried out with the ESA1 are relative measurements. Thus it is important to define a measurement set-up and document the initial state first.

Measuring results from previous measurements under standard conditions provide crucial information on critical frequency ranges and the extent of necessary improvements. First analyze the measurement set-up required for these measurements:

- How have the PCBs been installed in the unit under test?
- Which connected cables are possible decoupling paths?
- How do these cables run inside and/or outside the unit under test? (e.g. cable harness in the car in the immediate vicinity of a large metal surface)
- Which metal parts such as housing, shielding, stud bolts, water pipes etc. are in the immediate vicinity (capacitive coupling)?

These considerations help determine modules and parts of modules as potential RF sources and find the paths by which the high-frequency currents are possibly emitted. This information allows you to design a measurement set-up so that the decisive emitted currents can be measured.

To confirm the measurement set-up, compare your measurement results with the results obtained in far-field measurements. There will be deviations of course. However, it is crucial in this comparison to find critical frequencies from far-field measurements with the chosen measurement set-up and thus to prove the existence of the suspected sources and associated decoupling paths.

3.2 ChipScan-ESA software

ChipScan-ESA is a universal tool in the development of electronic modules which allows the developer to manage the disturbance emission data measured with a spectrum analyzer.

The software enables:

- a quick and easy configuration of spectrum analyzers
- the logging of measured data for a quick comparison and for documentation
- the linear/logarithmic plotting of measured data in 2D/3D diagrams
- the storage of measured data for subsequent evaluation and comparison with further measured data if necessary
- the export of measured data as an image for publication, documentation, etc.
- the export of measured data as a .csv file for further processing in Excel, Matlab, Origin, R, etc.

Hereafter the software's characteristics are described in detail.

1) Easy and flexible portrayal of the measured data

All measured data can be displayed in both a 2D and 3D diagram.

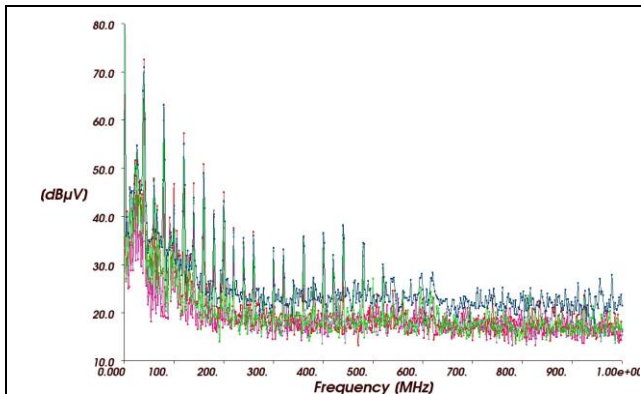

Figure 16 2D diagram

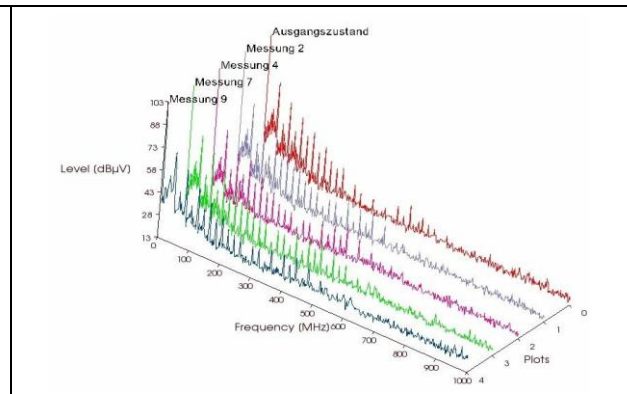

Figure 17 3D diagram

It does not matter if the measured data was recorded in different frequency ranges. Individual measurement curves can be displayed or hidden and each curve can be assigned a certain color or description to provide a better overview. Furthermore, gridlines allow the developer to compare measurement curves very precisely in the linear or logarithmic 2D diagram.

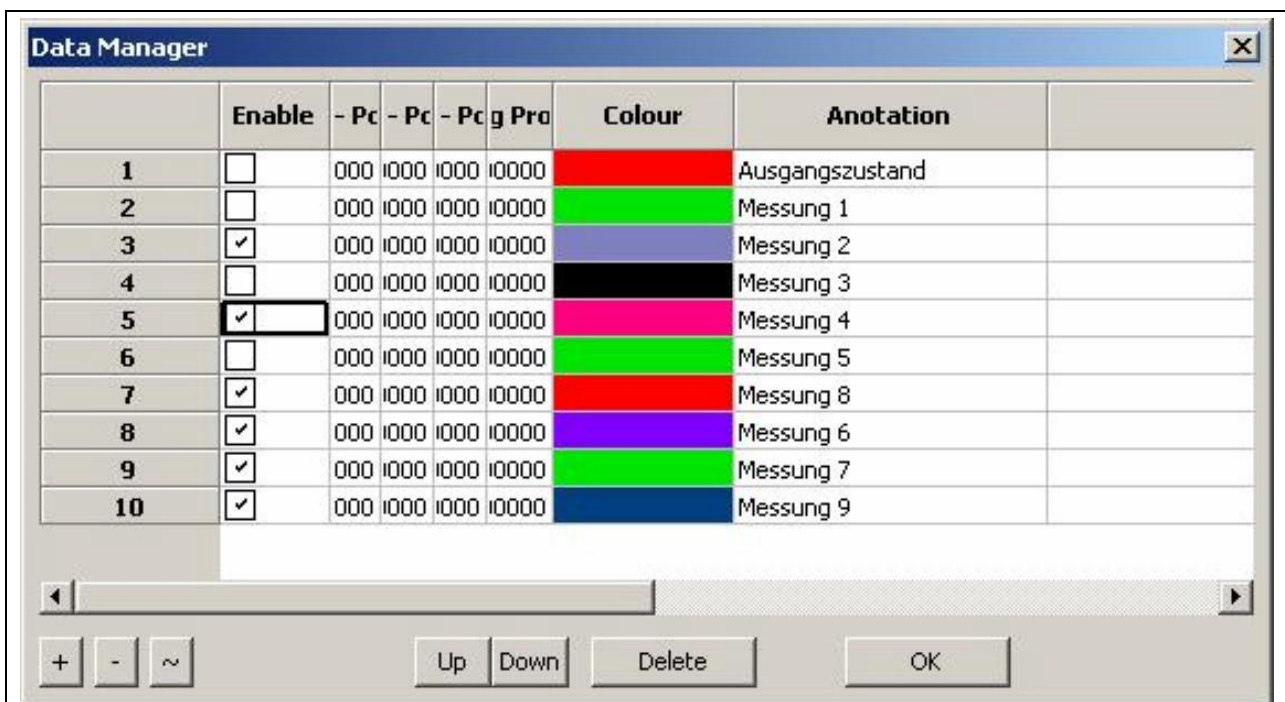

Figure 18 Data Manager

2) Storage and export of measured data

Any amount of measured data can be stored in a file. This file can be reloaded from ChipScan-ESA at any time as required. The data can be recorded first and evaluated later. In addition, new measurements can be compared with older ones.

Any number of measurement plots can be exported optionally as an image or a .csv file to edit the measured data for publication or documentation. The .csv export allows the developer to process the measured data using statistical software such as Excel, Matlab, Origin and R.

3) Fast and easy handling of spectrum analyzers / frequency generators

All the important device settings can conveniently be carried out with the ChipScan-ESA software and all supported spectrum analyzers can be controlled via a uniform operator interface.

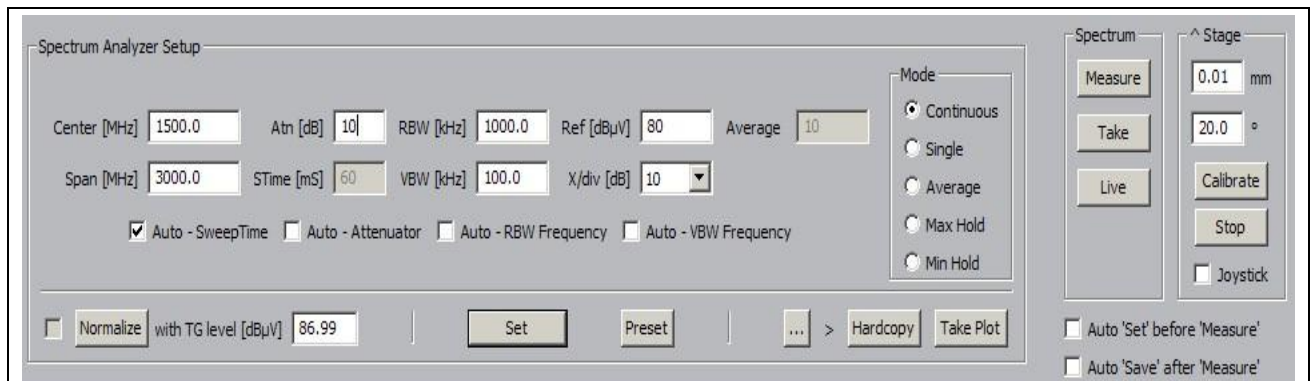

Figure 19 Spectrum Analyzer Setup

In addition, the device settings can also be stored in configuration files and reloaded. This prevents any operating errors which may occur in measurement logs.

ChipScan-ESA automatically recognizes all (see list of supported devices¹) measuring instruments connected to the PC irrespective of the interface used (RS232, GPIB, VXI) even if several measuring instruments are connected simultaneously. The recognized devices can also be stored in configuration files and reloaded.

3.3 Localization through global changes to the unit under test

The unit under test often allows you to locate the emission sources by changing the measurement set-up. These include

a) geometrical changes:

- Changing the distance between the unit under test and ground plate.
- Use sheet steel to simulate neighboring modules or housings.
- Plugging in and removing cables, changing the cable length and position.
- Eliminating individual RF sources by disconnecting individual modules, partial shielding or by using ferrite magnets.

b) changes to the operating procedure:

- Using another software or program or program section.
- Observing the spectrum when the program is running up.
- Switching off individual sections of the unit under test.
- Operating the unit under test under permanent reset conditions – only the clock line is maintained.

¹<https://www.langer-emv.com/en/product/software/25/cs-esa-set-chipscan-esa-software-cd-rom/163#Manual05>

3.4 Reason analysis with near field probes

Carry out near-field measurements to exactly determine the RF sources that emit disturbances. The goal is to correlate the currents measured with the RF current transformer to the RF fields on the module. You should proceed as shown in **Figure 20**:

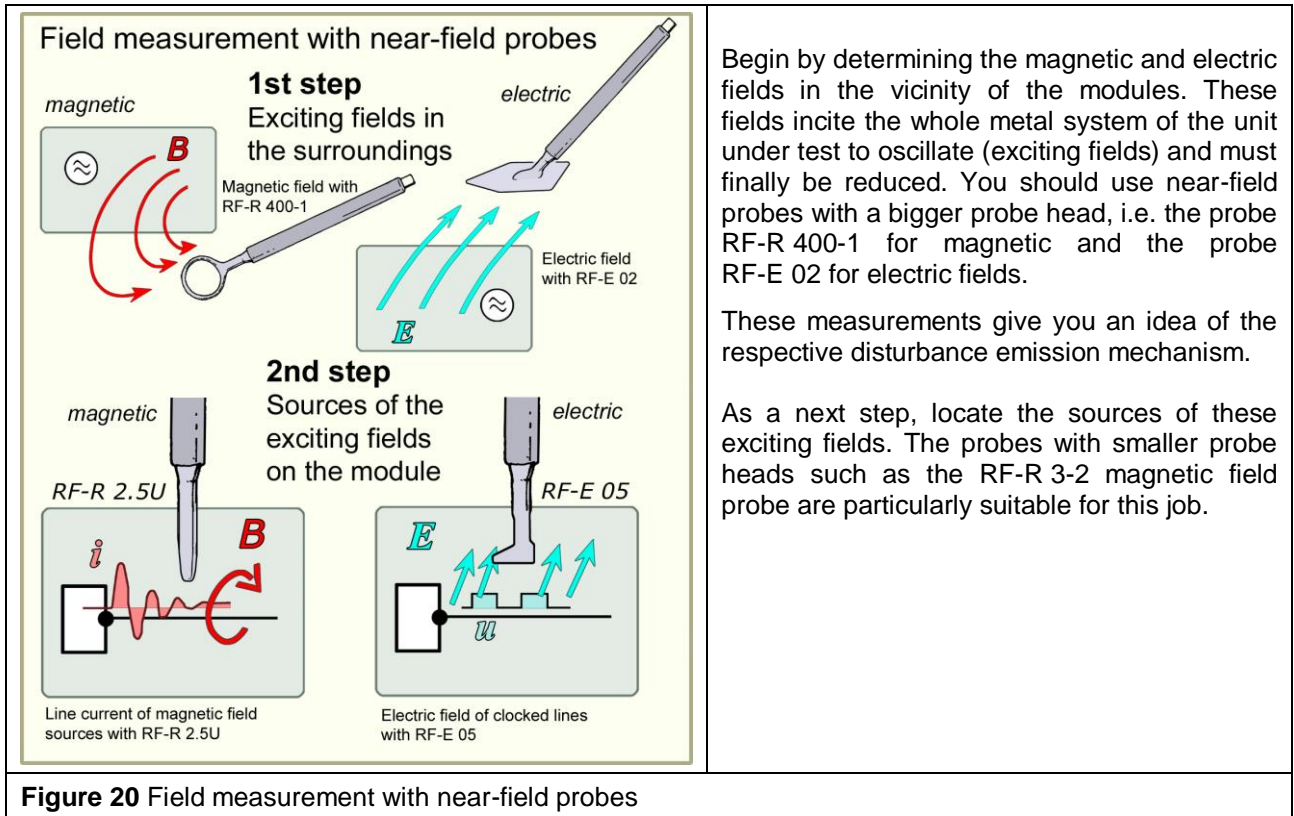

In each measurement you determine

- the field strength at a certain frequency or within a certain frequency range and
- the direction of the magnetic field lines by rotating the magnetic field probe (magnetic field measurements).

The following fields should be considered as potential RF sources:

- electric fields above components such as processors
- electric fields on switched lines and bus systems
- magnetic fields on switched data and clock lines
- magnetic fields on power supply lines

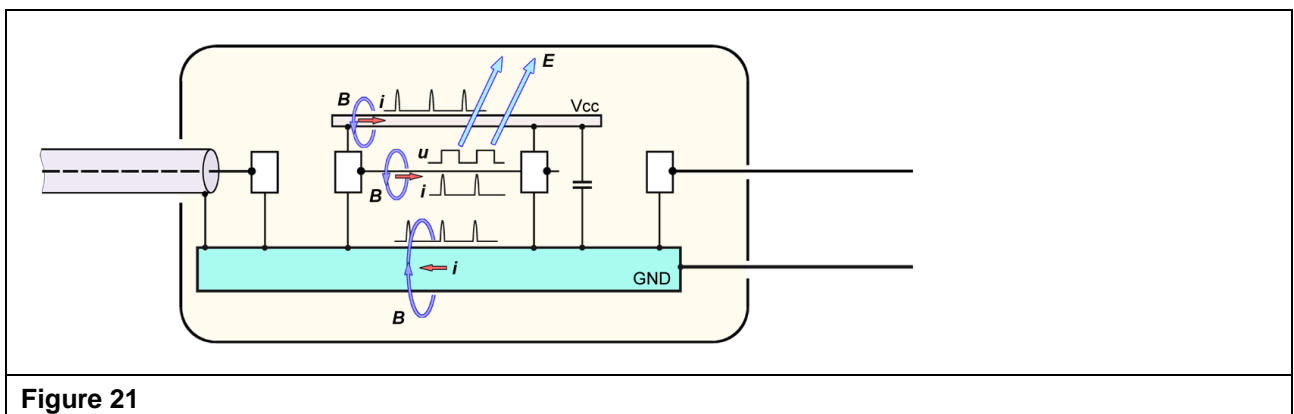

3.5 Modification of the module

There are various starting points for modifying a module:

- a) Modifying the module's geometry with regard to
 - plug-and-socket connectors and cable connections
 - the layout
 - the surrounding metal system

- b) Changing the circuitry by
 - inserting damping resistors, filters
 - changing the operating procedure

The RF sources have to be modified so that the field strength is reduced (damping) or the lines of force are kept in the immediate vicinity of the source and do not exit the module.

Having detected the potential disturbing fields on the module, you will automatically have ideas and possibilities on how to reduce these fields. Potential modifications are:

- Confining the magnetic fields through metal surfaces
- Shielding electric fields through GND areas
- Inserting damping resistors in signal lines

Perform another measurement with the HFW 21 to check the effect of the implemented modifications. Evaluate the modification, take other measures if necessary and only carry out a further acceptance measurement if there is a decisive improvement in the module.

4 Measurement set-up variants

4.1 Measurement of the common-mode component

4.1.1 Unit under test with one cable terminal

If only one cable, e.g. the power supply cable, is connected to the unit under test, its leads are filtered first through the GP 23 ground plate and then through the HFW 21 (Input: Power and output COM). The RF current flows through the parasitic capacitance between the unit under test and ground plate to the ground plate and back to the unit under test through the HFW 21 via the power supply cables (**Figure 22** and **Figure 23**).

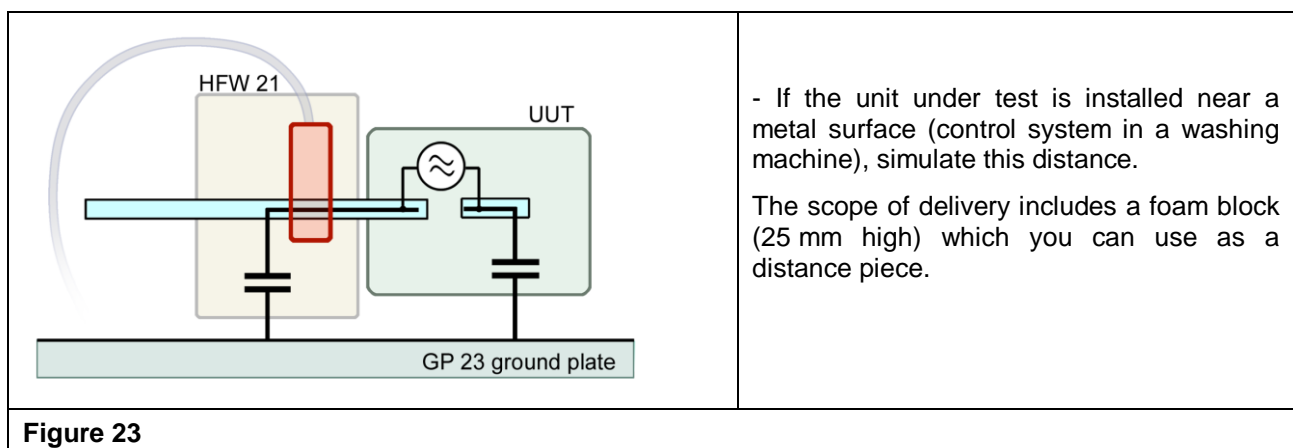
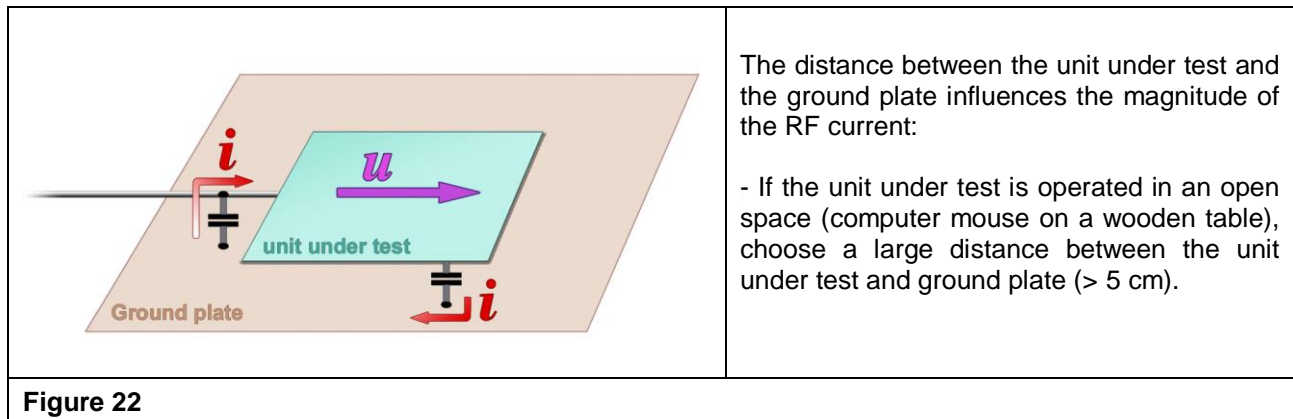

The capacitance between the unit under test and ground plate is determined by the size and distance of the unit under test. The RF current flows through this parasitic capacitance. This may be caused by electric fields on the surface of the unit under test which are generated by large surface clocked bus systems.

In some cases it will not be possible for you to pass the single cable through the current transformer, e.g. if

- more than two wires are needed,
- the current consumption of the unit under test is too high,
- the supply voltage is too high.

In such cases you should connect the unit under test via the usual cable and connect its GND directly to the ground plate via the HFW 21 by as short a cable connection as possible. A large part of the RF current which is normally fed to the cable will be diverted via the HFW 21 and measured. You can make this procedure more effective by inserting a choke into the cable.

4.1.2 Unit under test with several cable terminals

The aim is a measurement set-up which is as simple and easily comprehensible as possible. All cables that are not crucial for operating the unit under test are thus disconnected. A restricted function due to missing data, for example, is generally acceptable because essential RF sources on the module, such as the clock line and processor, are still operational in this case even if minor changes arise due to other program sequences, for example. After having found and minimized the main disturbance emissions causes, carry out respective control measurements and, if necessary, connect one cable after the other (**Figure 24** and **Figure 25**).

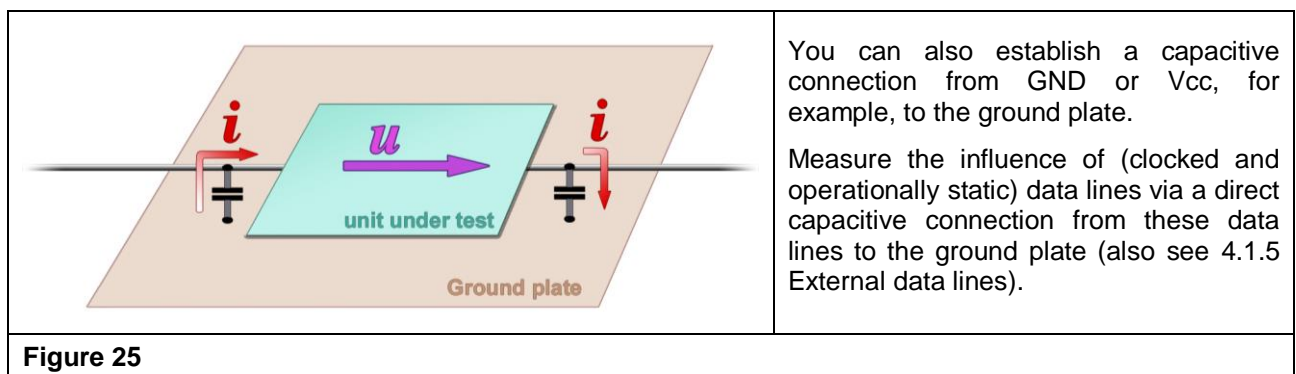
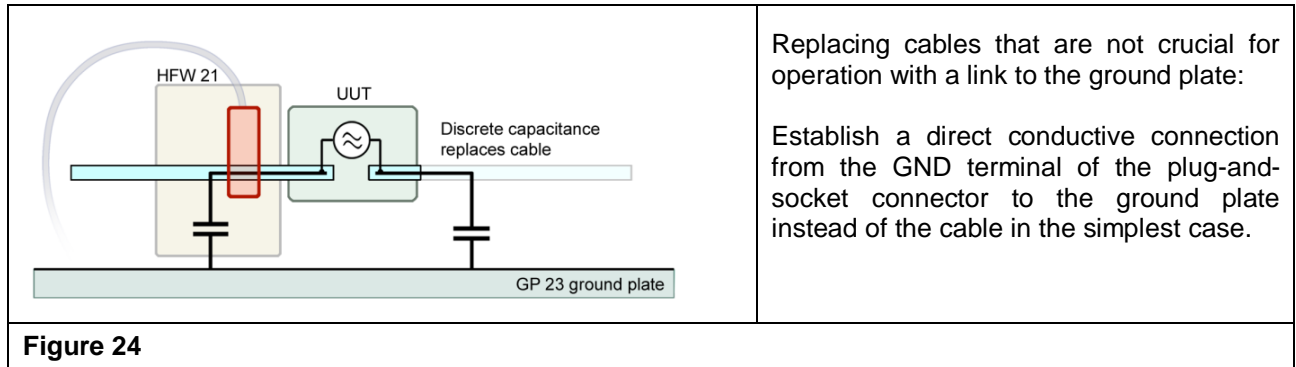

4.1.3 Unit under test with indispensable cables

If you cannot disconnect and simulate cables by an equivalent capacitance or conductive connection for functional reasons, you have to put and fix the cable on the ground plate (**Figure 26**). If the cable leaves the ground plate, use ferrites (still on the ground plate) to prevent the cable position and length outside the defined measurement set-up from interfering with the measurement result and prevent interference currents, which flow in from the surroundings via these cables from being damped.

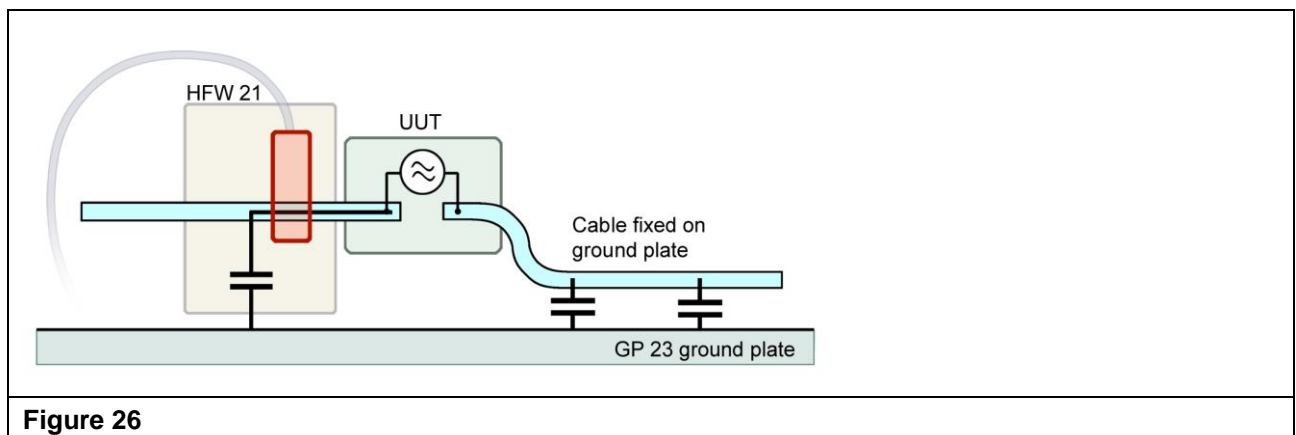

4.1.4 Example: Measurements on a complex unit under test

In many cases, different effects of various RF sources within the unit under test will first be superposed and lead to an amplification or reduction of the RF fields at particular frequencies. It is therefore important for an effective reason analysis, particularly with complex units under test comprising several modules, to dismantle the unit under test and deal with individual modules separately.

The unit under test shown in **Figure 27** has several potential disturbance emission sources. We only consider here the interface module plugged on to the basic unit as an example:

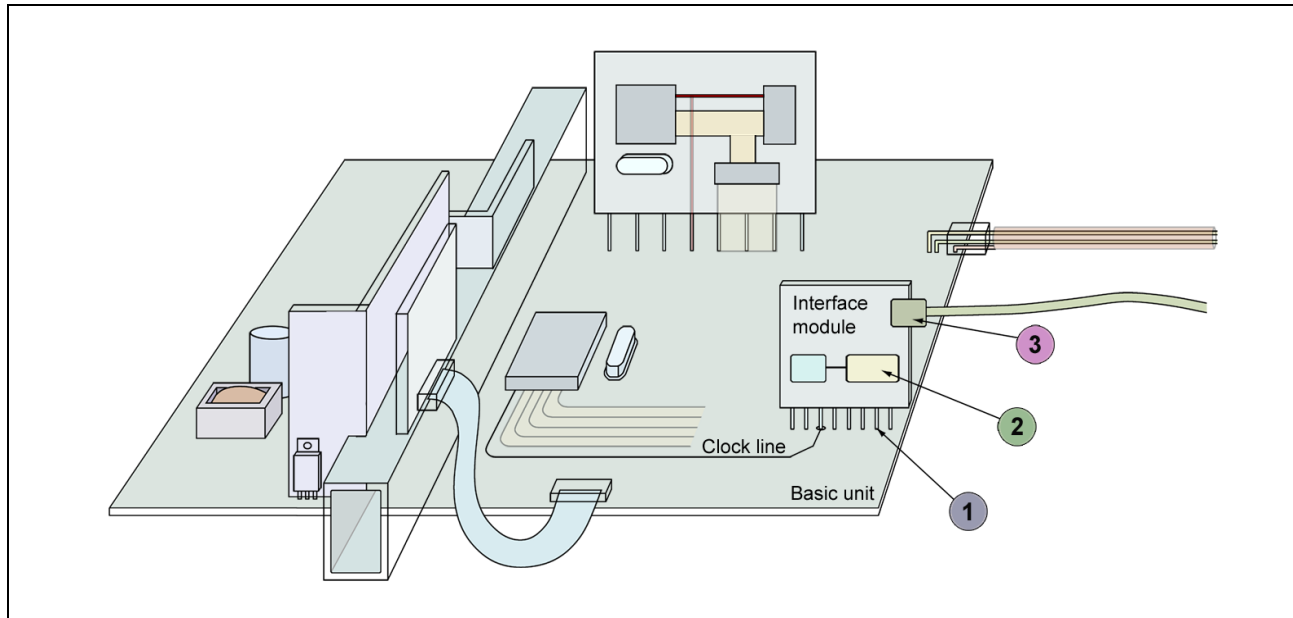

Figure 27 RF sources on the interface module

Three RF sources are likely to cause emissions:

- 1) plug-and-socket connector between basic unit and interface module
- 2) electronic components (processor with memory chip) on the interface module
- 3) data streams generated by the interface module and fed into the connected cable

Deal with these three RF sources in succession. You will need measurement set-ups that largely blank out the other RF sources of the unit under test and those of the basic unit.

1) Plug-and-socket connector between basic unit and interface module

Assumption:

The basic unit and interface module are connected to each other via data and control lines. These lines are well protected by the basic unit and interface module in the area of the GND systems – but in the area of the plug-and-socket connector they lie in the open air. The high-frequency shares of the signals sent via these lines generate RF magnetic fields which can dissipate freely in the atmosphere and can cause voltage differences between the GND of the basic unit and that of the interface module. These voltage differences drive RF currents into the cable that is connected to the interface module and thus cause emissions (**Figure 28**).

All other potential RF sources have to be largely eliminated to measure these voltage differences. To do so, make several connections between the GND of the basic unit and the GP 23 ground plate with copper foil adhesive tape (mainly in the area of the interface module). The basic unit's GND in the area of the interface module and the ground plate are thus equipotential – the voltage differences caused by other sources are short-circuited to the greatest possible extent. Also disconnect the data cable from the interface module provided the data transfer between interface module and basic unit is not dramatically reduced by this measure.

Measurement:

Now briefly connect a COM output of the HFW 21 with the GND of the interface module (**Figure 28**). The voltage difference generated in the area of the plug-and-socket connector causes a compensating current to flow through HFW 21 and its capacitive connection to the ground plate back to the GND of the basic unit. This compensating current is measured with the HFW 21 and reflects the amount of the plug-and-socket connector area's share of disturbances being emitted by the whole unit under test. The effects of modifications such as filters or changing the plug assignment are directly measurable.

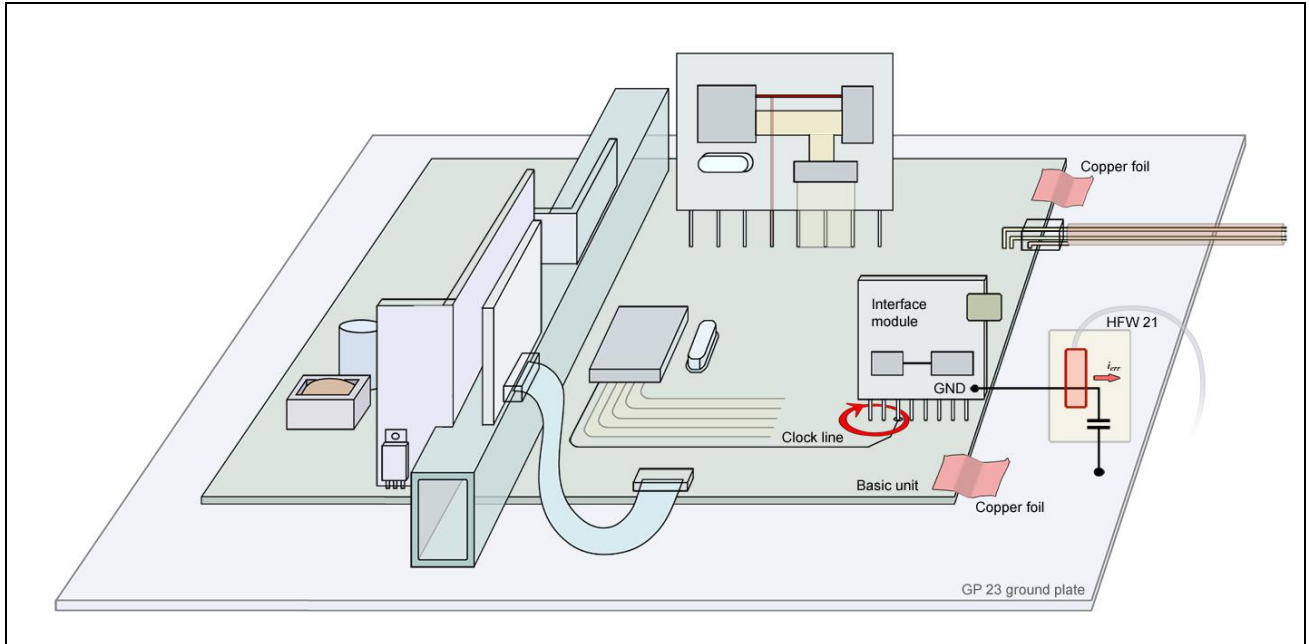

Figure 28 GND of the interface module connected to the COM output of the HFW 21

2) Electronic components (processor with memory chip) on the interface module

Assumption:

The electronic components on the interface module generate currents in the GND system of the interface module which provoke a voltage drop between the connection points of the two plug-and-socket connectors. This voltage difference is decoupled via the data cable and causes disturbance emissions.

Measurement:

The basic unit is still connected to the GP 23 ground plate. The remaining share of the plug-and-socket connector between interface module and basic unit is dramatically reduced by several large-area GND connections between both GND surfaces (**Figure 29**).

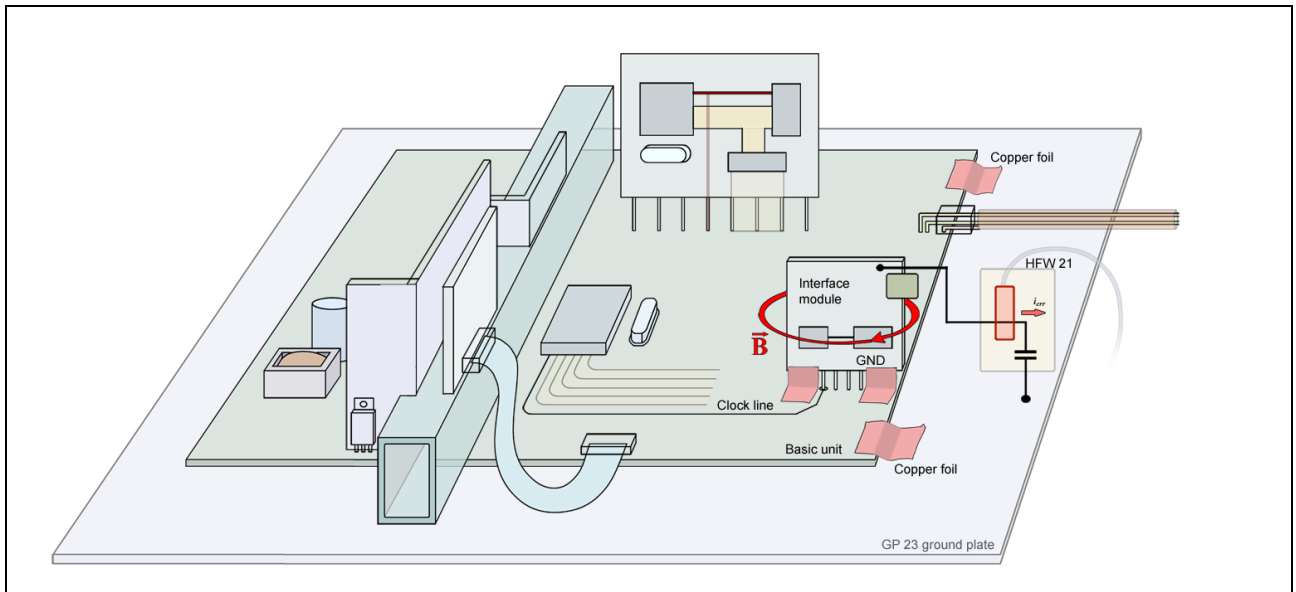

Figure 29 Evaluation of the modifications with the HFW 21

Tap the voltage directly at the GND terminal of the interface plug via a short measuring cable to the COM port of the HFV 21. Thus the modifications that have been made directly on the interface module can be evaluated.

3) Data streams fed into the connected cable

Assumption:

The interface driver module feeds a RF current into the signal wires of the data cable. This current couples to the shield via the cable capacitance of signal wire - shield and flows back to the GND of the interface module. It generates a voltage difference between the shield and GND in the area of the shield connection which causes disturbances being emitted.

Measurement:

Carry out this measurement without changing the measurement set-up. Simply connect the HFV 21 directly to the shield of the plugged-in data cable (**Figure 30**). Thus the voltage drop can be detected as expected.

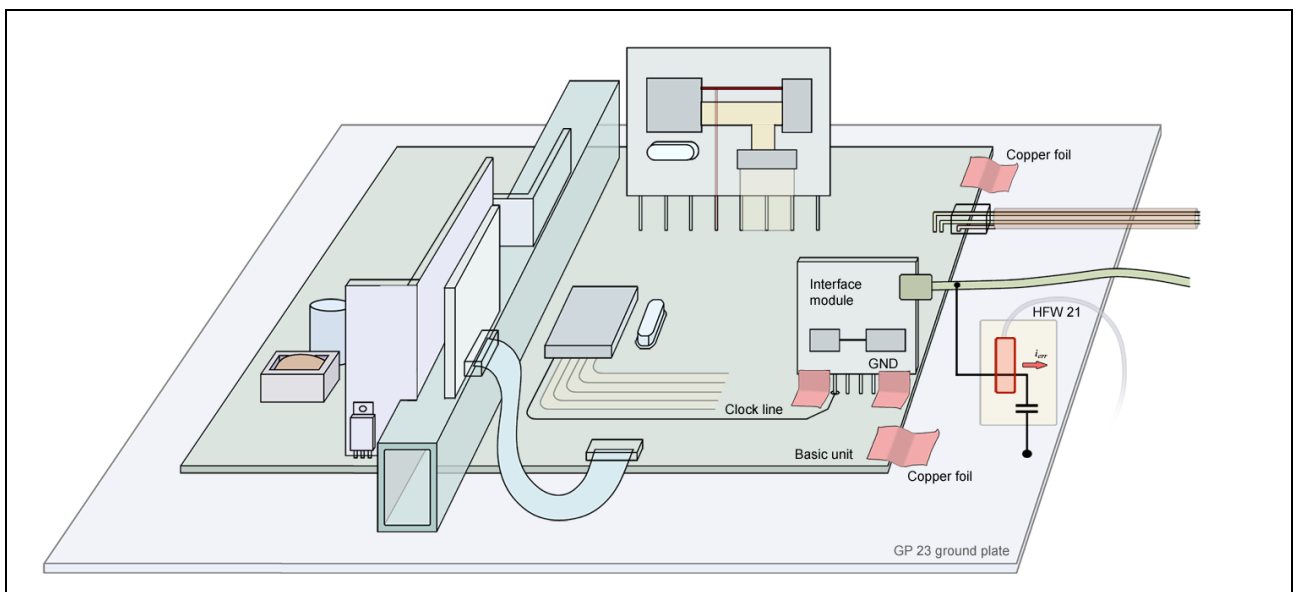

Figure 30 HFV 21 detects the voltage drop on the shield of the connected data cable

This set-up has a disadvantage: the voltage differences remaining from the areas of the basic unit, plug-and-socket connector and GND of the interface module are measured as well. Wherever functionally possible, you should initially operate the interface module separately without the basic unit (**Figure 31**). The module's performance characteristics, e.g. without data being sent by the basic unit, will of course differ from those under normal operating conditions. If the clock line works and the processor is in operation, however, relative measurements of the currents and fields generated by the processor, for example, are possible. You can easily evaluate modifications to the GND and supply systems.

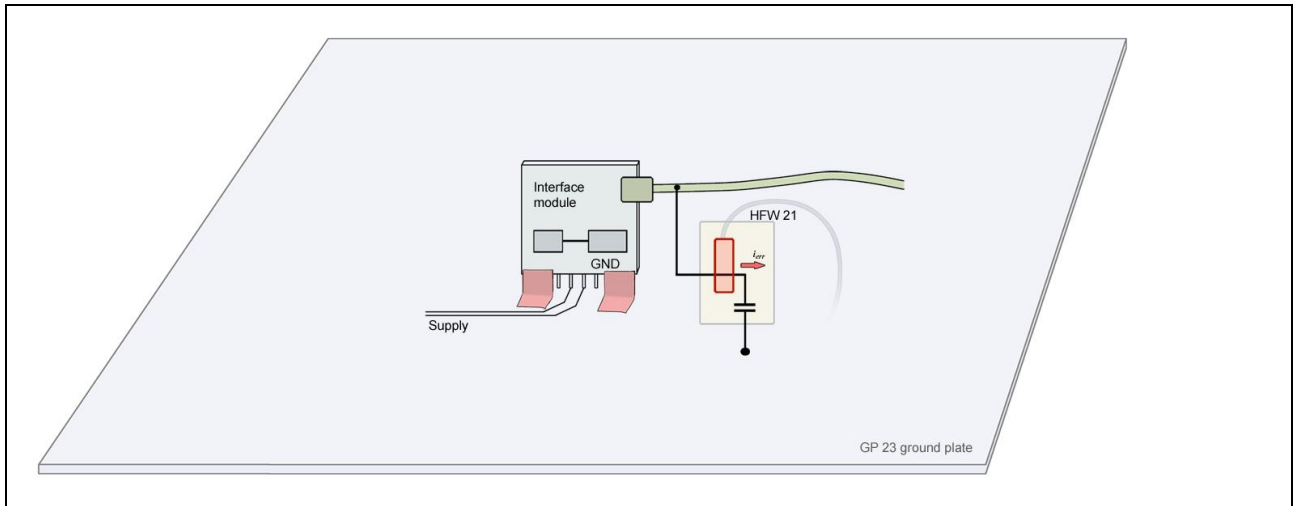

Figure 31 Set-up without the basic unit

4.1.5 External data lines

1) Measuring the RF current on data lines

To measure the RF current on data lines, simulate the capacitance of the line connected under normal operating conditions and lead the RF current through the RF current transformer (**Figure 32**). The RF current circuit is closed through the capacitance of other lines relative to the ground plate or through capacitive or conductive coupling between the unit under test and ground plate (e.g. with battery-operated devices). This procedure is particularly suitable for dimensioning data line filters. If the unit under test drives a remote LCD display via a ribbon cable, for example, disconnect the lines to the display on the unit under test side and only connect one line to one of the COM outputs of the HFW 21 via an equivalent capacitance and optimize this line first. Apply the filter circuit you have found to other signal lines later on.

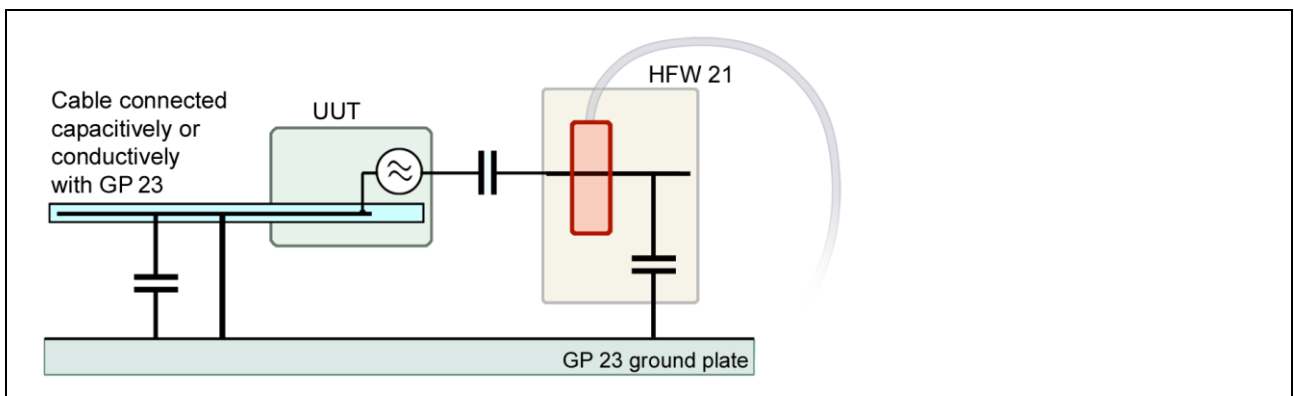

Figure 32

2) Measuring the effect on the unit under test

Simultaneous measuring of the RF current on many lines, such as those of a ribbon cable, is not possible. In such cases you have to carry out the measurement according to **Figure 33**:

Do not measure the RF current directly on the signal lines but on another cable (e.g. on the opposite power supply connection) or, if there is no other cable present, directly on the GND as described under 4.1.1. Replace the data lines with capacitances relative to the GP 23 ground plate.

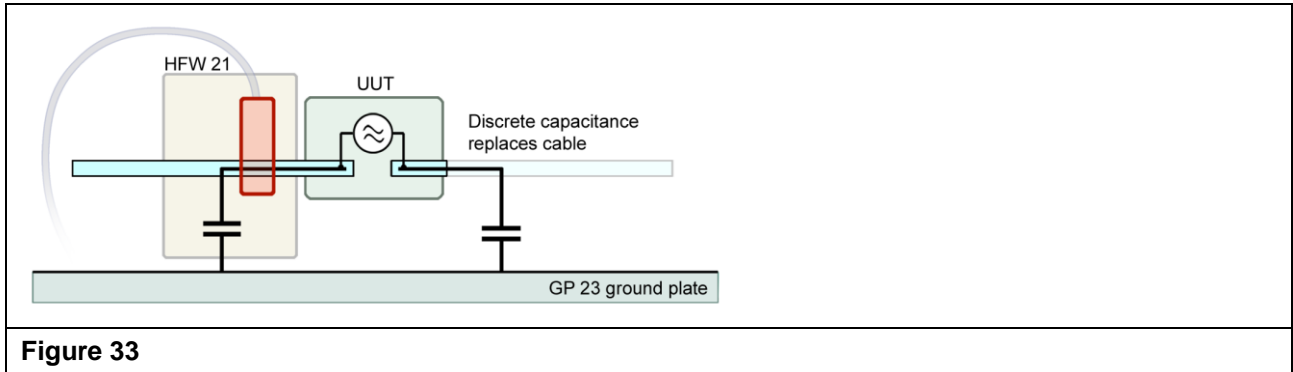

Figure 33

4.2 Measurement of the differential-mode component

Beside the common-mode currents measured so far (the RF currents in all wires of a cable travel in the same direction), differential-mode currents, which are mainly generated in the power supply unit of DC/DC converters or by clocked loads (e.g. via PWM) are of interest in the lower frequency range. The RF current transformer enables these measurements via the DIFF port (**Figure 34**).

According to the disturbance emission mechanism described under chapter 1, this differential-mode current does not result in any disturbance emissions. But since it also flows in the ground of the chassis or GND connections between different devices, voltage differences develop between these devices. These in turn cause compensating currents (common-mode currents) which cause disturbance emissions.

The differential-mode currents in units under test containing a DC/DC converter or a similar device have to be measured and, if necessary, reduced by capacitors or chokes because these currents are partially transformed into critical common-mode currents according to the described mechanism.

The output signal is damped (saturation effect) depending on the power consumption of the unit under test (see point 7) in the frequency range below 10 MHz if the RF differential-mode current is measured on the supply lines of the unit under test. This effect does not occur above this frequency or if the measurement is carried out via the COM common-mode output.

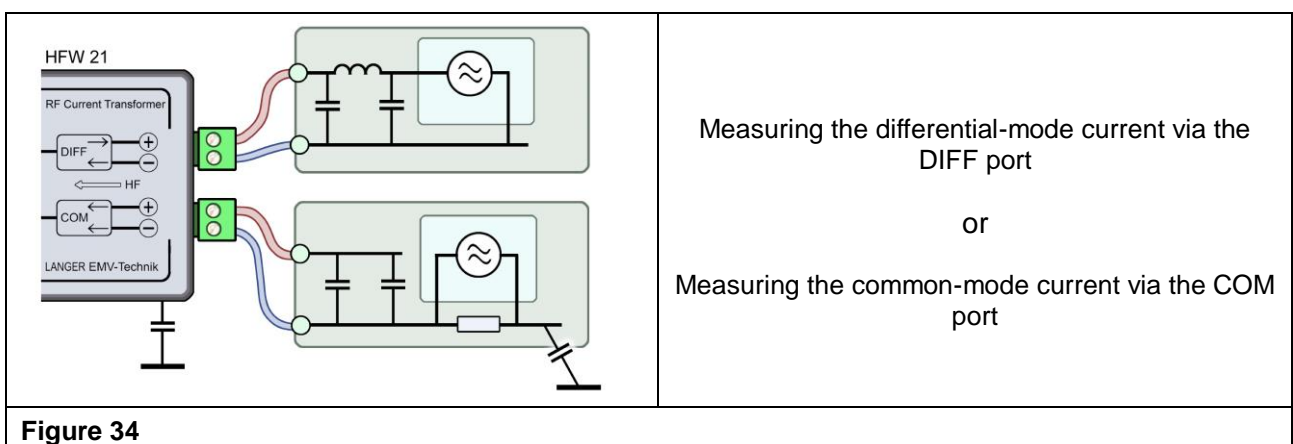

Figure 34

5 Safety instructions

This product is conformed to the requirements of the following European Union regulations: 2004/108/EG (EMC Directive) and 2006/95/EG (low-voltage directive).

When using a product from LANGER EMV-Technik GmbH, please observe the following safety instructions to protect yourself from electric shocks or the risk of injuries.

Read and follow the manual instructions and keep them in a safe place for later consultation. The device may only be used by personnel who are qualified in the field of EMC and who are able to work under the influence of disturbance voltages and (electric and magnetic) burst fields.

- Observe the operating and safety instructions for all devices used in the set-up.
- Never use any damaged or defective devices.
- Carry out a visual check before using a measurement set-up with a Langer EMV-Technik GmbH product. Replace any damaged connecting cables before starting the product.
- Never leave a Langer EMV-Technik GmbH product unattended while this is in operation.
- The Langer EMV-Technik GmbH product may only be used for its intended purpose. Any other use is prohibited.
- People with pace-makers are not permitted to work with this device.
- In principle, the test set-up should always be operated via a filtered power supply.

Attention! Functional near fields and interference emissions may occur when operating Pulse- and RF generators or in connection with field sources. The user is responsible for taking measures to protect the correct function of products outside the EMC environment of the test set-up (in particular against interference). This can be achieved by:

- observing an appropriate safety distance
- using shielded or shielding rooms.

Attention! Measuring devices may be destroyed due to the simultaneous use of Pulse- / RF generators and measuring devices, e.g. oscilloscope and spectrum analyzer. It is the user's responsibility to prevent damage from these instruments. Protect measuring devices by:

- Preconnection of filters in signal and supply lines
- Using shielded lines
- Shielding measuring devices

The shielding has to be done with highest care! One gap at a single spot can lead to the loss of the whole shielding system effect!

The disturbances that are injected into the assemblies can functionally destroy (latch-up) the device under test if their intensity is too high. Protect the device under test by:

- preconnecting a protective resistor in the IC power supply
- increasing the disturbance step by step, stopping when a functional fault occurs
- interrupting the power supply to the device under test in the event of a latch-up

Attention! Make sure that internal functional errors are visible from outside. The device under test may be destroyed due to an increase in the injection intensity if the errors are not visible outside. Take the following measures if necessary:

- monitoring of representative signals in the device under test
- special test software
- visible reaction of the device under test to inputs (reaction test of the device under test)

We cannot assume any liability for the destruction of devices under test!

6 Warranty

Langer EMV-Technik GmbH will remedy any fault due to defective material or defective manufacture, either by repair or by delivery of replacement, during the statutory warranty period.

This warranty is only granted on condition that:

- the information and instructions in the user manual have been observed.

The warranty will be forfeited if:

- an unauthorized repair is performed on the product
- the product is modified
- the product is not used according to its intended purpose

7 Technical parameters

7.1 Near-field probes

Characteristic	Description	Type
	<p>RF-R 3-2 The near-field probe is designed to achieve nearly punctiform detection of HF magnetic fields. The size of the probe enables the resolution of magnetic field distribution within millimetres. Field orientation and distribution can be detected by moving the probe across larger areas or partially between conducting paths, within IC pin areas, bypass capacitors, EMC components, etc.</p> <p>Frequency: 30 MHz to 3 GHz Resolution: approx. 1 mm</p>	
	<p>RF-U 2.5-2 The near-field probe is designed for selective detection of the current spectrum in singular small conducting paths and component connections, capacitors, IC pins. The probe head contains a magnetically active curb with a width of approx. 0.5 mm. To achieve measurement the probe with the curb is positioned on conducting paths, IC or capacitor connections.</p> <p>Frequency: 30 MHz to 3 GHz Resolution: approx. 0.5 mm</p>	
	<p>RF-R 400-1 On account of its large diameter (25 mm) the near-field probe is the most sensitive and therefore has the lowest resolution. The probe can be used up to a distance of 10 cm from units. The detected field distribution enables the localisation of RF magnetic field sources and deduction with regards to interference.</p> <p>Frequency: 30 MHz to 3 GHz Diameter (Ø): approx. 25 mm</p>	
	<p>RF-R 50-1 The near-field probe has a higher resolution and a lower sensitivity than the R 400-1. It is suitable for measurements up to 3 cm. Interference sources can be localized by detecting the distribution and orientation of the field, therefore enabling a more exact use of higher resolution probes (RF 1 set).</p> <p>Frequency: 30 MHz to 3 GHz Diameter (Ø): approx. 10 mm</p>	

	<p>RF-U 5-2 The near-field probe is designed for detecting surface and circular magnetic fields on very wide conducting paths, metallized surfaces, plug-and-socket connectors, electronic components, cables and component connections. The sources of RF magnetic fields can be detected and conclusions regarding internal interference currents achieved.</p> <p>Frequency: 30 MHz to 2 GHz Resolution: approx. 5 mm</p>	
	<p>RF-B 3-2 The near-field probe is designed for the detection of magnetic fields which are emitted vertically from the surface area of flat units. The probe enables measurement of obstructed parts of the printed circuit board. It is not possible to conduct measurements of field orientation such as can be done with the RF-R 3-2 probe.</p> <p>Frequency: 30 MHz to 3 GHz Resolution: approx. 2 mm</p>	
	<p>RF-B 0.3-3 detects a magnetic field, which enters the probe's head vertically. It is therefore suitable for pin-point detection of RF magnetic fields, which are emitted by surfaces. For this, the probe head is placed on the surface in question. Due to its very small construction, magnetic field distributions of under 1 millimeter can be resolved on IC housings and PCB surfaces, for example. The probe enables measurements in hard-to-reach places, such as between components.</p> <p>Frequency: 30 MHz to 3 GHz Resolution: < 1 mm</p>	
	<p>RF-R 0.3-3 allows for high-resolution detection of spatial RF magnetic fields. The loop opening, which is marked by a white dot, can be manually turned to identify field orientation and intensity. If the loop opening is orthogonally permeated by the field, a maximum can be detected. The minimum can be detected by pivoting the loop opening by 90°. This allows the detection of H-field distribution (orientation and intensity) by guiding the probe in the vicinity of components, between and over track runs, in the pin area of ICs, on block capacitors, EMC components, etc.</p> <p>Frequency: 30 MHz to 3 GHz Resolution: < 1 mm</p>	
	<p>RF-E 02 Bus structures, larger components, and supply areas couple out electrical fields by their surfaces. These electrical fields may be the cause of electromagnetic emission. The probe RF-E 02 detects these fields via the probe bottom on an area of approx. 2 cm x 5 cm.</p> <p>For measuring the probe is gradually brought closer or is put directly on the Unit Under Test.</p> <p>Frequency: 30 MHz to 1.5 GHz</p>	

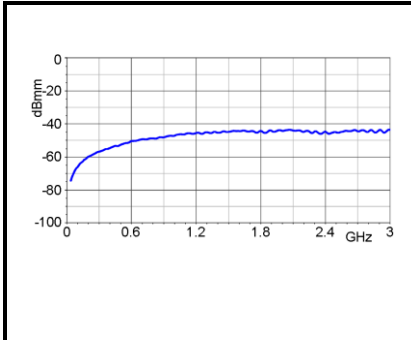

RF-E 05 With this probe you are able to register selectively electrical fields on layouts and component area of flat units. The breadth of the field electrode is about 1 mm. Therefore you can locate electrical fields very accurately. These electrical fields are caused by clocked lines, IC pins and small components.

Frequency: 30 MHz to 3 GHz

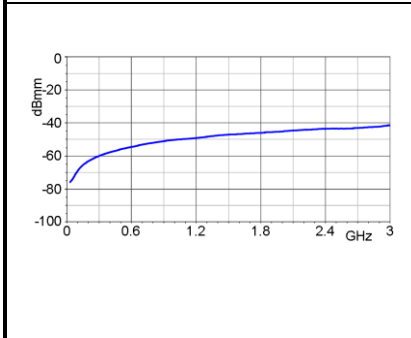
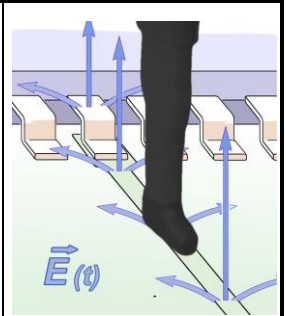

RF-E 10 The near-field probe detects electrical fields that clocked leads emit via their surface. The probe head tip is approx. 0.5 mm wide. The integrated screening prevents interference to the measurement result from neighboring leads. A resolution of approx. 0.2 mm is possible so that each individual track can be evaluated in the layout.

Frequency: 30 MHz to 3 GHz

Resolution: approx. 0.2 mm

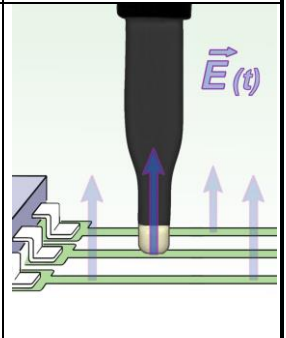

7.2 HFW 21 RF current transformer:

Max. continuous current	10 A
Max. operating voltage	50 V

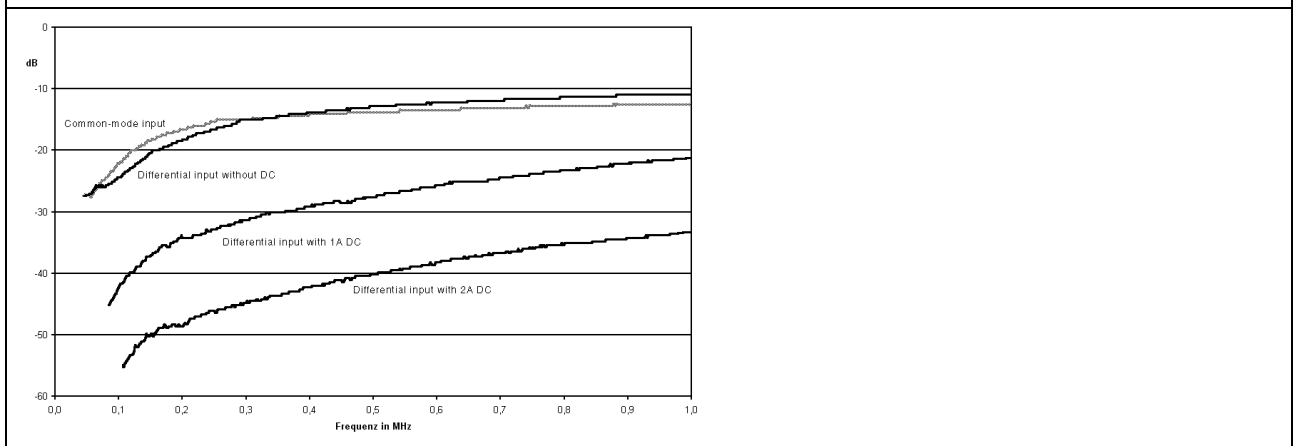
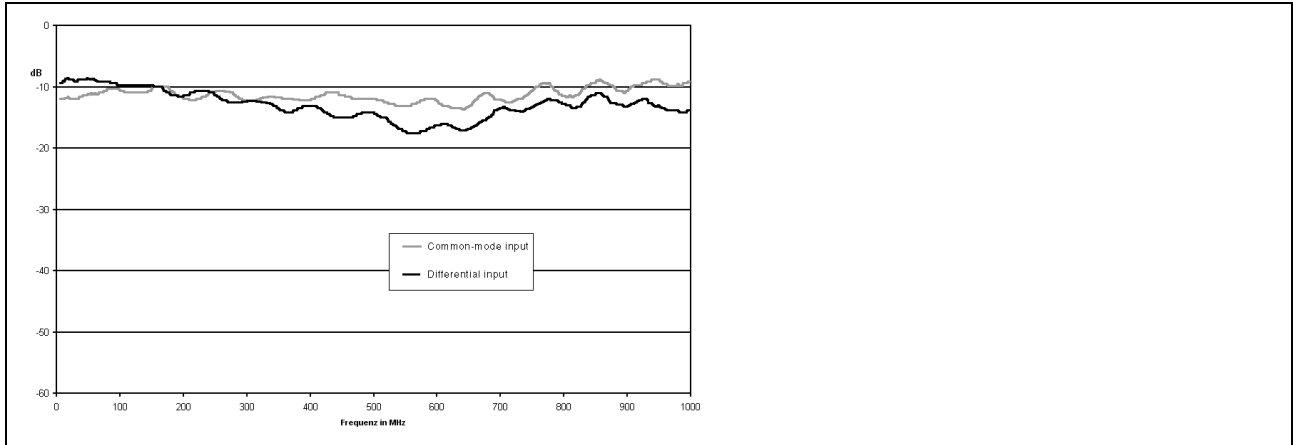

Figure 35 HFW 21 transfer performance

7.3 HFA 21 RF bypass

Capacitances	10 pF to 100 nF
Max. operating voltage	50 V

7.4 GP 23 ground plate

Working area	(900 x 500) mm
---------------------	----------------

	Max. continuous current	Damping
Mains	10 A	50 dB at 1 MHz – 1 GHz
DC socket 12 V	2.5 A	40 dB at 1 MHz – 1 GHz
Pole terminal	10 A	50 dB at 1 MHz – 1 GHz

7.5 Z23-1 shielding tent

	Working room (length x width x height)	Damping
Z23-1	(900 x 500 x 400) mm	45 – 50 dB at 30 MHz – 1 GHz)
Z23-2 (optional)	(900 x 500 x 650) mm	45 – 50 dB at 30 MHz – 1 GHz)

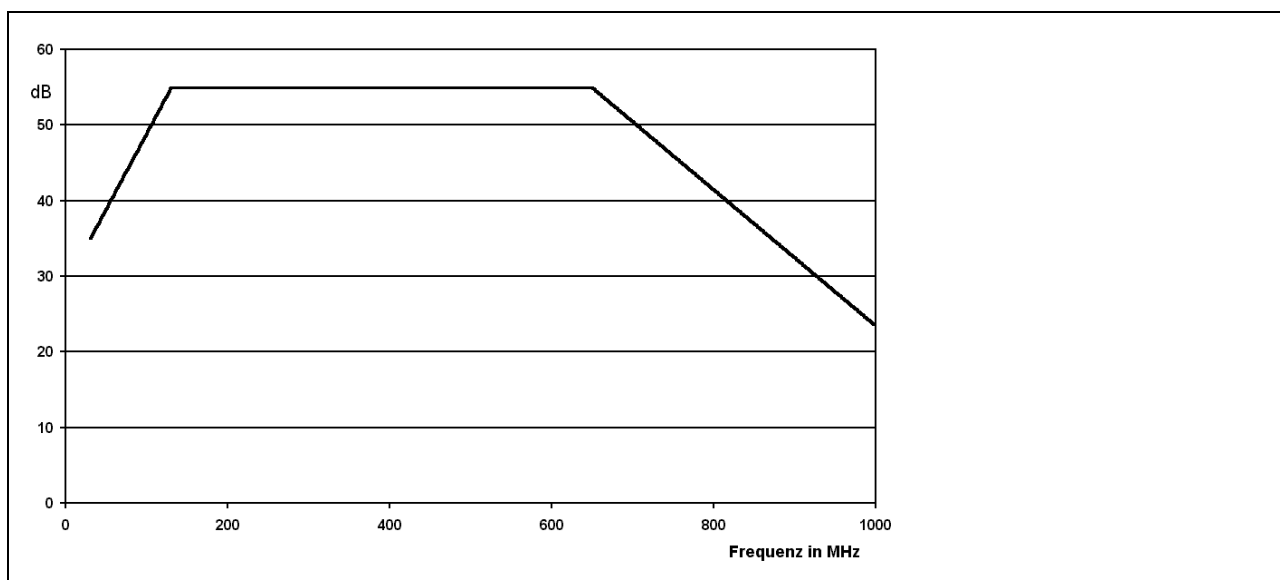

Figure 36 Approximate shield damping with the shielding tent closed

7.6 PA 203 preamplifier

Max. input power	13 dBm
Voltage supply	12 V DC
Current input	50 mA
Amplification	20 dB
Noise figure	4.5 dB

8 Scope of delivery

Item	Designation	Type	Parameter	Quantity
01	RF current transformer	HFW 21		1
02	RF bypass	HFA 21		1

03	Tent poles*	ZG 23-1		1
04	Shielding material*	BZ 23-1		1
05	Ground plate	GP 23		1

06	H-Field Probe mini	RF-B 0.3-3	30 MHz – 3 GHz	1
07	H-Field Probe	RF-B 3-2	30 MHz – 3 GHz	1
08	H-Field Probe mini	RF-R 0.3-3	30 MHz – 3 GHz	1
09	H-Field Probe	RF-R 3-2	30 MHz – 3 GHz	1
10	H-Field Probe	RF-R 50-1	30 MHz – 3 GHz	1
11	H-Field Probe	RF-R 400-1	30 MHz – 3 GHz	1
12	H-Field Probe	RF-U 2.5-2	30 MHz – 3 GHz	1
13	H-Field Probe	RF-U 5-2	30 MHz – 3 GHz	1
14	E-Field Probe	RF-E 02	30 MHz – 1.5 GHz	1
15	E-Field Probe	RF-E 05	30 MHz – 3 GHz	1
16	E-Field Probe	RF-E 10	30 MHz – 3 GHz	1

17	Preamplifier	PA 203 BNC		1
18	Power supply unit	NT FRI EU		1

19	Measurement cable, ds	BNC-BNC ds		1
20	Measurement cable	SMB-BNC 1 m		1
21	Measurement line, red	ML rt 7 cm		2
22	Measurement line, yellow	ML ge 12 cm		2
23	Measurement line, black	ML sw 25 cm		1
24	Terminal block	AK 2 pole		2
25	Terminal block with header	AK ST 2 pole		2
26	Cable	LK 25 cm bl		1
27	Cable	LK 25 cm rt		1
28	Power split cable		20 cm	1
29	Micro kleps			2
30	Alligator clip			2

Item	Designation	Type	Parameter	Quantity
31	Foam block		25 cm	1
32	Probe tip			1

33	ChipScan-ESA software	CS-ESA		1
34	Dongle			1

35	User manual			1
36	Laminated quick guide			1
37	ESA1 system case			1

* The shielding tent is alternatively available with a taller working space ((900 x 500 x 650) mm). The use is analogous to the above description.



Figure 37 Taller working space with ZG 23-2 and BZ 23-2 installed on GP 23 ground plate

8.1 Content of the ESA1 case



Figure 38 ESA1 case

This document may not be copied, reproduced or electronically processed, either in its entirety or in part, without the prior written permission of Langer EMV-Technik GmbH. The management of Langer EMV-Technik GmbH assumes no liability for damage that may arise from using this printed information.

Langer EMV-Technik-GmbH

Noethnitzer Hang 31
DE-01728 Bannewitz
www.langer-emv.com

Tel.: +49(0)351/430093-0
Fax: +49(0)351/430093-22
mail@langer-emv.de