



# Operation and Service Manual

---

## Hypot<sup>®</sup> Series

Models 3805, 3855, 3865, 3870 and 3880

### Dielectric Withstand Voltage Instrument

AC/DC Hipot, Insulation Resistance, and Continuity Test Instruments

*USB Interface standard on all models*

---

Serial \_\_\_\_\_

Item 40068 • Version 1.08

June 2024



# DECLARATION OF CONFORMITY



**Manufacturer:** Associated Research  
An Ikonix Brand

**Address:** 28105 North Keith Drive  
Lake Forest, IL 60045 USA

**Product Name:** Hypot® Dielectric Withstand Voltage Tester

**Model Number:** 3805/3855/3865/3870/3880

## Conforms to the following Standards:

**Safety:** UL 61010-1:2012, UL 61010-2-030:2012, UL 61010-031:2007 R7.10, CAN/CSA-C22.2 NO. 61010-1-12, CAN/CSA-C22.2 NO. 61010-031-07 + A1:2010, CAN/CSA-C22.2 NO. 61010-2-030-12, EN 61010-1:2010+A1:2019, EN 61010-2-034: 2021+A11, BS EN 61010-2-034:2021+A11: 2014, IEC 61010-2-034:2021+A11: 2014, BS EN 61010-1:2010+A1:2019, EN 61010-031:2002+A1:2008, BS EN 61010-2-030: 2010, BS EN 61010-031:2002+A1:2008

**EMC:** EN 61326-1:2013 Class A / BS EN 61326-1:2013 Class A  
EN55011:2009+A2:2010 Group 1, Class A  
BS EN55011:2009+A2:2010 Group 1, Class A  
EN 61000-3-2:2014 / IEC 61000-3-2:2014 (Ed. 4.0)  
BS EN 61000-3-2:2014  
EN 61000-3-3:2013 / IEC 61000-3-3:2013 (Ed. 3.0)  
BS EN 61000-3-3:2013  
EN 61326-1:2013 (industrial locations) / BS EN 61326-1:2013 (industrial locations)  
EN 61000-4-2:2009 / IEC 61000-4-2:2008 (Ed. 2.0) / BS EN 61000-4-2:2009  
EN 61000-4-3:2006+A1:2008+A2:2010  
IEC 61000-4-3:2006+A1:2007+A2:2010 (Ed. 3.2)  
BS EN 61000-4-3:2006+A1:2008+A2:2010  
EN 61000-4-4:2012 / IEC 61000-4-4 :2012 (Ed. 3.0) / BS EN 61000-4-4:2012  
EN 61000-4-5:2006 / IEC 61000-4-5 :2005 (Ed. 3.0) / BS EN 61000-4-5:2006  
EN 61000-4-6:2014 / IEC 61000-4-6 :2013 (Ed. 4.0) / BS EN 61000-4-6:2014  
EN 61000-4-8:2010 / IEC 61000-4-8 :2009 (Ed. 2.0) / BS EN 61000-4-8:2010  
EN 61000-4-11:2004 / IEC 61000-4-11:2004 (Ed. 2.0) / EN 61000-4-11:2004

## Supplementary Information

The product herewith complies with the requirements of the Low Voltage Directive 2014/35/EU, the EMC Directive 2014/30/EU and the RoHS Directive 2015/863/EU with respect to the following substances: Lead (Pb), Mercury (Hg), Cadmium (Cd), Hexavalent chromium (Cr (VI)), Polybrominated biphenyls (PBB), Polybrominated diphenyl ethers (PBDE), Deca-BDE, Bis(2-ethylhexyl) phthalate, Dibutyl phthalate, Benzyl butyl phthalate, Diisobutyl phthalate included.

**Last two digits of the year in which the CE marking was affixed: 17**

The technical file and other documentation are on file with Associated Research

Adam Braverman  
President  
Associated Research  
Lake Forest, Illinois USA  
December 2022

# Warranty Policy

Ikonix, certifies that the tester listed in this manual meets or exceeds published manufacturing specifications. This tester was calibrated using standards that are traceable to the National Institute of Standards and Technology (NIST).

Your new tester is warranted to be free from defects in workmanship and material for a period of (5) years from date of shipment. We aim to provide an amazing experience and quality testers that last a long time. If you're not satisfied with your tester, return it within 45 days for a full refund. Calibrate annually with us, or one of our authorized partners, and we'll extend your warranty an additional year for the service life of your tester, and at least five years after discontinuation. If it breaks during that time, we promise to fix it for free (unless abuse or excessive damage is present). When your tester reaches the end of its service life, we'll responsibly recycle it and give you a discount on a replacement. Annual calibration and inspection must be made in each successive year starting one year after the original purchase date in order to remain eligible for extended warranty coverage beyond the standard warranty period (five years).

Ikonix recommends that your tester be calibrated on a twelve-month cycle. A return material authorization (RMA) must be obtained from Ikonix. To obtain an RMA please contact our Customer Support team at 1-847-367-4077 or visit [arisafety.com](http://arisafety.com). Damages sustained as a result of improper packaging will not be honored. Transportation costs for the return of the tester for warranty service must be prepaid by the customer. Ikonix will assume the return freight costs when returning the tester to the customer. The return method will be at the discretion of Ikonix.

Except as provided, herein Ikonix makes no warranties to the purchaser of this tester and all other warranties, expressed or implied (including, without limitation, merchantability or fitness for a particular purpose), are hereby excluded, disclaimed and waived.

Any non-authorized modifications, tampering or physical damage will void your warranty. Elimination of any connections in the earth grounding system or bypassing any safety systems will void this warranty. This warranty does not cover accessories not of Ikonix manufacture. Parts used must be parts that are recommended by Ikonix as an acceptable specified part. Use of non-authorized parts in the repair of this tester will void the warranty.

\*5 year warranty is valid on any model purchased in 2021 or after.

## Operator Modifications

Any non-authorized modifications, tampering or physical damage will void this warranty. Elimination of any connections in the earth grounding system or bypassing any safety systems will void this warranty. This warranty does not cover accessories not of Associated Research manufacture. Parts used must be parts that are recommended by Associated Research as an acceptable specified part. Use of non-authorized parts in the repair of this instrument will void the warranty.

Associated Research will not be responsible for any injuries sustained due to unauthorized equipment modifications or use of parts not specified by Associated Research Instruments returned to Associated Research with unsafe modifications will be returned to their original operating condition at your expense.

# Table of Contents

<a href="#">Safety Precautions and Warning Symbols for High Voltage Testing</a>	6
<a href="#">Front Panel Controls (3805,3855,3865,3870)</a>	7
<a href="#">Rear Panel Controls (3805,3855,3865,3870)</a>	8
<a href="#">Front Panel Controls (3880)</a>	9
<a href="#">Rear Panel Controls (3880)</a>	10
<a href="#">Setup Instructions</a>	11
<a href="#">Getting to Know Your Instrument</a>	12
<a href="#">Main Menu</a>	14
1. <a href="#">Setup System</a>	15
2. <a href="#">Setup Tests</a>	36
2.1 <a href="#">Setup AC Withstand Test</a>	37
2.2 <a href="#">Setup DC Withstand Test</a>	39
2.3 <a href="#">Setup Insulation Resistance Test</a>	41
3. <a href="#">Perform Test</a>	47
4. <a href="#">Security</a>	55
5. <a href="#">FailCHEK</a>	57
6. <a href="#">MyMenu</a>	60
<a href="#">Using Remote I/O and PLC Control</a>	61
<a href="#">Appendix A - Installation and Test Operator Information</a>	64
<a href="#">Installation</a>	64
1. <a href="#">Unpacking and Inspection</a>	64
2. <a href="#">Safe Lifting and Carrying Instructions</a>	64
3. <a href="#">Contents of the Carton</a>	64
4. <a href="#">Preparation for Use</a>	65
5. <a href="#">Power Cable</a>	65
<a href="#">Operating Environment</a>	66
<a href="#">Storage and Shipment</a>	66
<a href="#">Test Operator and Safety Considerations</a>	66
1. <a href="#">Qualifications</a>	66
2. <a href="#">Safety Procedures</a>	67
3. <a href="#">Dress</a>	67
4. <a href="#">Medical Restrictions</a>	67
5. <a href="#">Test Station</a>	67
<a href="#">Appendix B - Instrument Specifications</a>	69
<a href="#">Appendix C - Series Options</a>	73
<a href="#">Appendix D - Remote Bus Interface: RS-232</a>	77
<a href="#">Appendix E - Replacement Parts List</a>	93
<a href="#">Appendix F - Calibration Procedure</a>	95

NOTE: This is an interactive PDF, if viewing on a computer click on our [quick links](#) to jump quickly to that section. Return to the Table of Contents by simply clicking on the page number with a ▲ above it in the bottom right corner.

# Safety Precautions and Warning Symbols for High Voltage Testing

**GENERAL:** Review this product and its related documentation for familiarization with safety markings and instructions before operation.

This product is a Safety Class I instrument (provided with a protective earth terminal). Before applying power verify that the input voltage to the instrument is 115VAC±10% or 230VAC±10% and the correct fuse is installed.



Product will be marked with this symbol when it is necessary to refer to the operation and service manual in order to prevent injury or equipment damage.

S'il vous plaît se référer au manuel d'instructions de mise en garde ou information sur la prudence pour éviter des blessures ou des dommages au produit



Product will be marked with this symbol when hazardous voltages may be present.

Avertissement des tensions dangereuses qui peuvent être présentes.



Product will be marked with this symbol at connections that require earth grounding.

Le produit sera marqué de ce symbole au niveau des connexions qui nécessitent à la terre.

## Caution and Warning Symbols

### WARNING

Calls attention to a procedure, practice, or condition that could possibly cause bodily injury or death.

Appelle l'attention sur une procédure, une pratique ou une condition qui pourrait causer des blessures corporelles ou la mort.

### CAUTION

Calls attention to a procedure, practice, or condition that could possibly cause damage to equipment or permanent loss of data.

Appelle l'attention sur une procédure, une pratique ou une condition qui pourrait causer des blessures corporelles ou la mort.

### WARNING

The Hypot produces voltages and currents that can cause **harmful or fatal electric shock**. To prevent accidental injury or death, these safety procedures must be strictly observed when handling and using the test instrument.

Le Hypot, des tensions et des courants qui peuvent causer des chocs électriques dangereux ou mortel. Pour éviter toute blessure ou un décès accidentels, ces procédures de sécurité doivent être strictement respectées lors de la manipulation et l'utilisation de l'appareil de contrôle.

# Front Panel Controls (3805,3855,3865,3870)

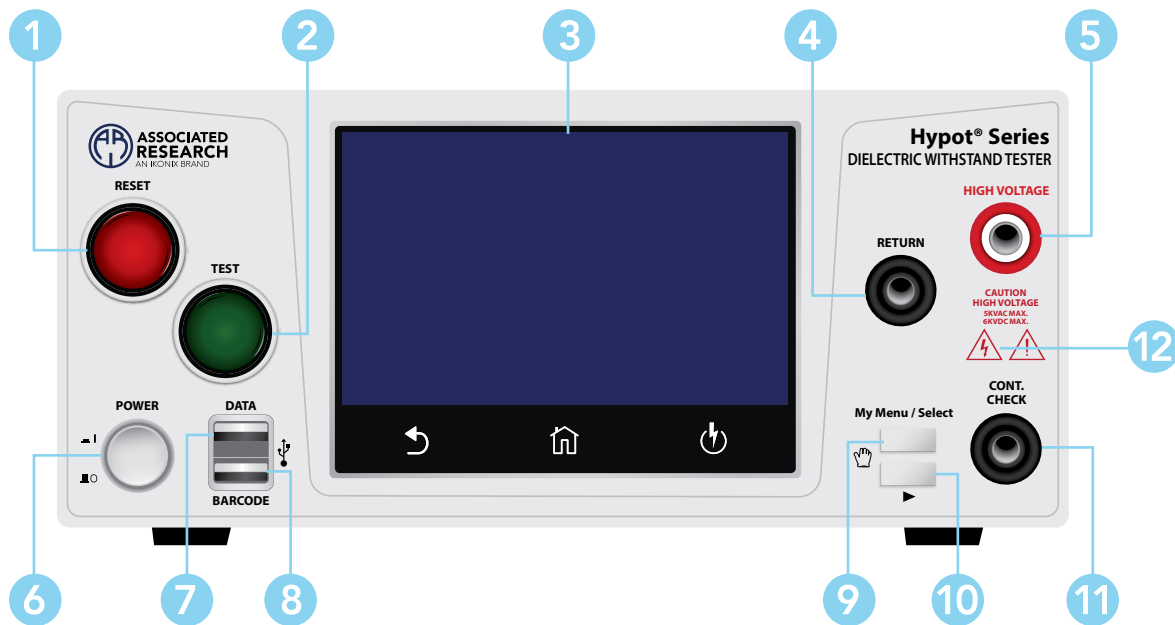

- 1 RESET BUTTON:** Resets the instrument. If a failure condition occurs during a test, pressing this button will reset the system, shut off the alarm and clear the failure condition. You must press the Reset button before performing another test or changing any of the setup parameters. This button also serves as an abort signal to stop any test in progress.
- 2 TEST BUTTON:** This is a momentary contact switch used to start a test. Press the green button to turn on the high voltage output when in test mode. The indicator lamp within the button will light when continuity is within limits for the built-in continuity test.
- 3 TOUCH SCREEN GRAPHIC LCD:** Displays all the information and allows full control of the instrument.
- 4 RETURN TERMINAL:** Connector used to attach the return test lead, adapter box return lead or test fixture return lead to the instrument. This connection provides the return current path.
- 5 HIGH VOLTAGE OUTPUT TERMINAL:** Connector used to attach the high voltage test lead, adapter box high voltage lead or test fixture high voltage lead to the instrument. This connection provides the high voltage used during a Hipot test.
- 6 POWER SWITCH:** Powers the test instrument ON or OFF.
- 7 DATA USB PORT:** This USB style port allows for connecting a USB flash drive to extract test and system data.
- 8 BARCODE USB PORT:** This USB style port allows for connecting a barcode scanner.
- 9 MY MENU:** Brings up the MyMENU screen.
- 10 TOGGLE:** This button allows you to toggle between test files if you are wearing high voltage gloves.
- 11 CONT CHECK:** Provides the connection for checking ground continuity.
- 12 HIGH VOLTAGE INDICATOR:** Indicator flashes to warn the operator that high voltage is present at the high voltage output terminal.

# Rear Panel Controls

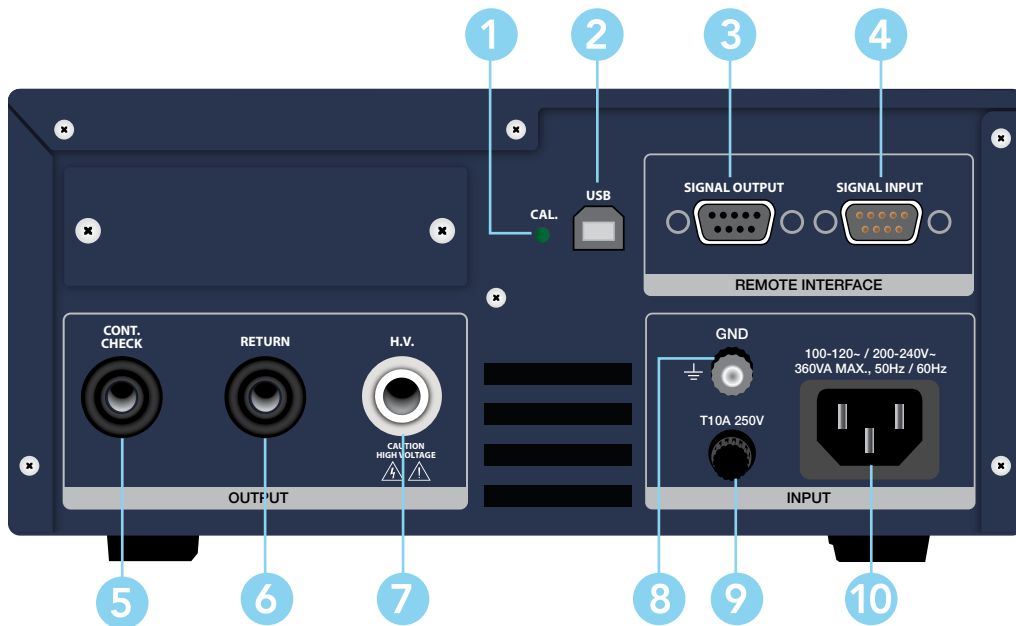

- 1 CALIBRATION BUTTON:** To put the instrument into the calibration mode push this button and turn on the power switch simultaneously.
- 2 USB CONNECTOR:** USB port for serial communication. Refer to Appendix D: Remote Bus Interface.
- 3 REMOTE SIGNAL OUTPUT:** 9 pin D subminiature female connector for monitoring PASS, FAIL, and PROCESSING output relay signals.
- 4 REMOTE SIGNAL INPUT:** 9-Pin D-type subminiature male connector for remote control of TEST, RESET, and REMOTE INTERLOCK DISABLE functions, as well as MEMORY SELECTION.
- 5 CONTINUITY CHECK:** 2nd continuity output connector in parallel with the front panel output.
- 6 RETURN:** 2nd return output connector in parallel with the front panel connector.
- 7 HIGH VOLTAGE OUTPUT:** 2nd high voltage output connector in parallel with the front panel connector.
- 8 CHASSIS GROUND EARTH TERMINAL:** This safety ground terminal should be connected to a good earth ground before operation.
- 9 FUSE RECEPTACLE:** To change the fuse, unplug the power (mains) cord and turn the fuse receptacle counter-clockwise. This will expose the fuse compartment. Please replace the fuse with one of the proper rating.
- 10 INPUT POWER RECEPTACLE:** Standard IEC 320 connector for connection to a standard NEMA style line power (mains) cord.

# Front Panel Controls (3880)

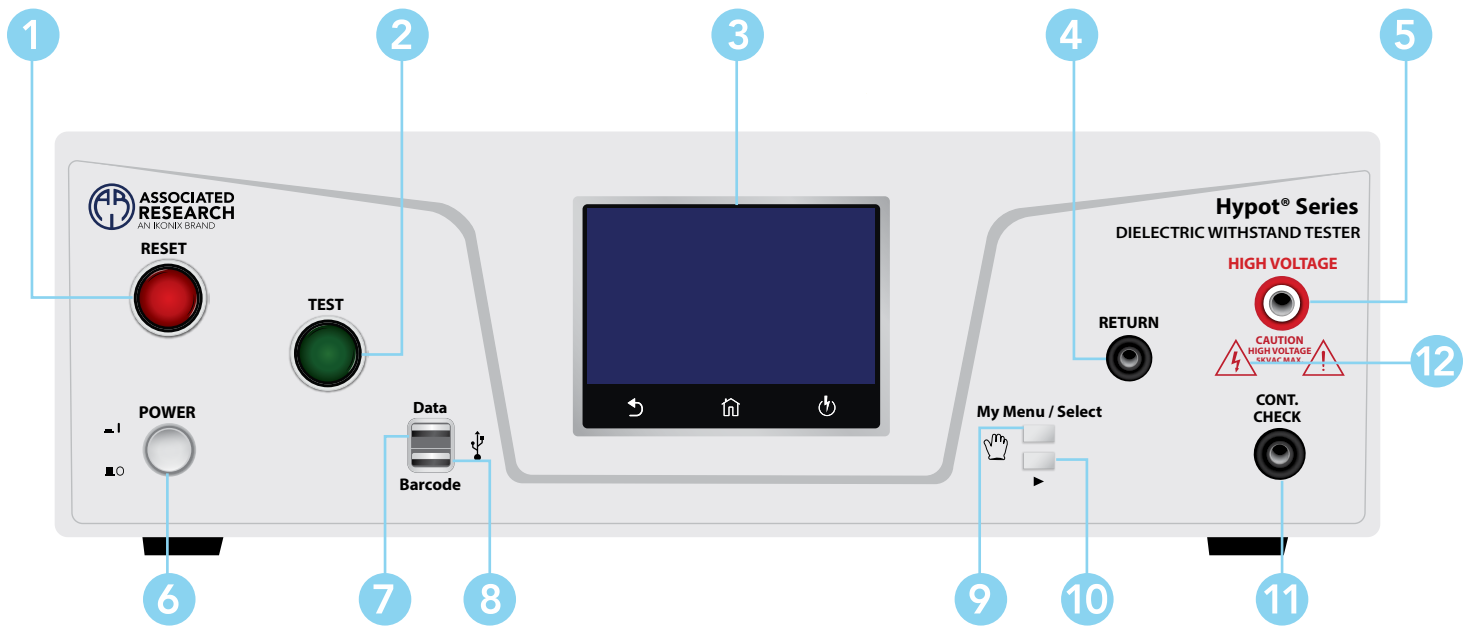

- 1 RESET BUTTON:** Resets the instrument. If a failure condition occurs during a test, pressing this button will reset the system, shut off the alarm and clear the failure condition. You must press the Reset button before performing another test or changing any of the setup parameters. This button also serves as an abort signal to stop any test in progress.
- 2 TEST BUTTON:** This is a momentary contact switch used to start a test. Press the green button to turn on the high voltage output when in test mode. The indicator lamp within the button will light when continuity is within limits for the built-in continuity test.
- 3 TOUCH SCREEN GRAPHIC LCD:** Displays all the information and allows full control of the instrument.
- 4 RETURN TERMINAL:** Connector used to attach the return test lead, adapter box return lead or test fixture return lead to the instrument. This connection provides the return current path.
- 5 HIGH VOLTAGE OUTPUT TERMINAL:** Connector used to attach the high voltage test lead, adapter box high voltage lead or test fixture high voltage lead to the instrument. This connection provides the high voltage used during a Hipot test.
- 6 POWER SWITCH:** Powers the test instrument ON or OFF.
- 7 DATA USB PORT:** This USB style port allows for connecting a USB flash drive to extract test and system data.
- 8 BARCODE USB PORT:** This USB style port allows for connecting a barcode scanner.
- 9 MY MENU:** Brings up the MyMENU screen.
- 10 TOGGLE:** This button allows you to toggle between test files if you are wearing high voltage gloves.
- 11 CONT CHECK:** Provides the connection for checking ground continuity.
- 12 HIGH VOLTAGE INDICATOR:** Indicator flashes to warn the operator that high voltage is present at the high voltage output terminal.



# Rear Panel Controls (3880)

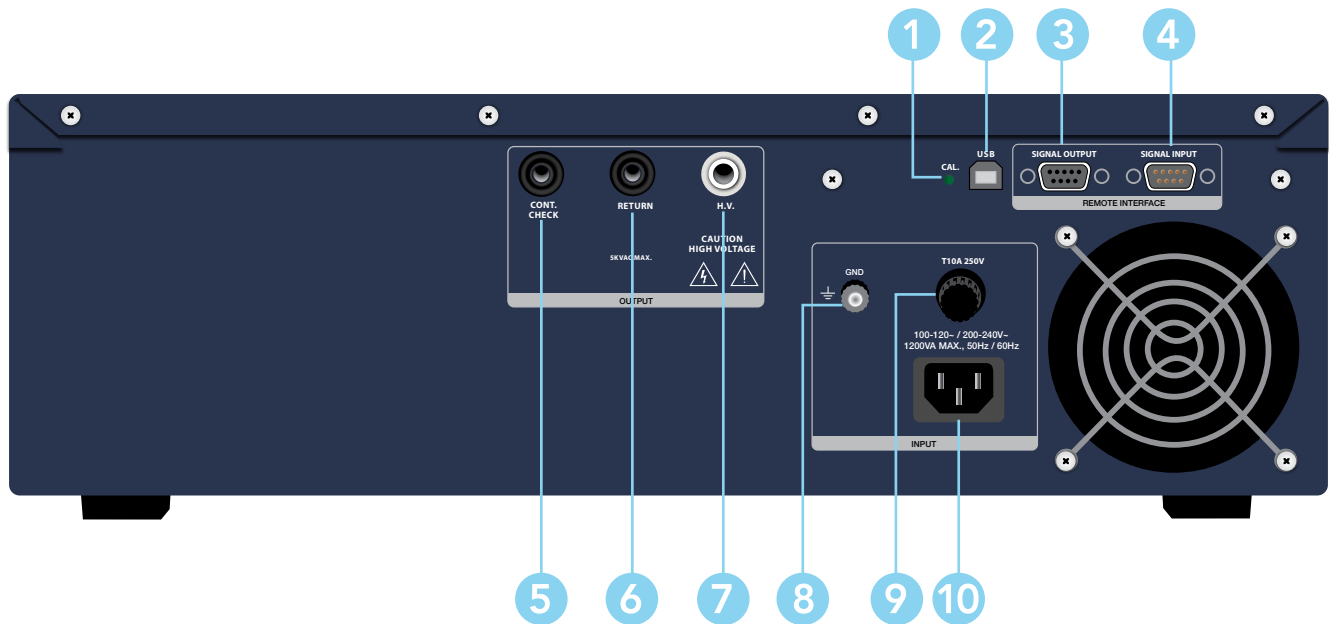

- 1 CALIBRATION ENABLE KEY:** To enter the calibration mode press this key while the tester is being powered ON.
- 2 USB CONNECTOR:** USB port for serial communication. Refer to Appendix D: Remote Bus Interface.
- 3 REMOTE SIGNAL OUTPUT:** 9 pin D subminiature female connector for monitoring PASS, FAIL, and PROCESSING output relay signals.
- 4 REMOTE SIGNAL INPUT:** 9-Pin D-type subminiature male connector for remote control of TEST, RESET, and REMOTE INTERLOCK DISABLE functions, as well as MEMORY SELECTION..
- 5 CONTINUITY CHECK:** 2nd continuity output connector in parallel with the front panel output.
- 6 RETURN:** 2nd return output connector in parallel with the front panel connector.
- 7 HIGH VOLTAGE OUTPUT:** 2nd high voltage output connector in parallel with the front panel connector.
- 8 CHASSIS GROUND EARTH TERMINAL:** This safety ground terminal should be connected to a good earth ground before operation.
- 9 FUSE RECEPTACLE:** To change the fuse, unplug the power (mains) cord and turn the fuse receptacle counter-clockwise. This will expose the fuse compartment. Please replace the fuse with one of the proper rating.
- 10 INPUT POWER RECEPTACLE:** Standard IEC 320 connector for connection to a standard NEMA style line power (mains) cord.

# Setup Instructions

## Power Up Sequence

1. Connect the power input plug into its socket on the rear panel of the instrument. Connect the male end of the plug to the outlet receptacle.



### WARNING

Only insert the main plug in a socket outlet with a protective ground (earth) contact. This protective ground must not be defeated by the use of an extension cord without a protective conductor.

La fiche principale ne doit être insérée dans une prise de courant avec une masse (terre) avec système de protection. Cette terre de protection ne doit pas être vaincu par l'utilisation d'une rallonge sans conducteur de protection.

2. Connect the Interlock Disable key to the Remote Input connector on the back panel of the instrument. This is required in order to run a test. For more information on the interlock, see section for Remote Interlock.



3. Turn on the POWER switch located on the lower left hand side of the front panel. Upon powering the instrument up, a POWER ON SELF TEST (POST) will automatically be performed. This test will check for the condition of the ram chips, PCB's and other critical components. The instrument screen will then default to the main menu.

The default screen is the main menu screen of the instrument. From this screen you can access all the functions and settings of the instrument:

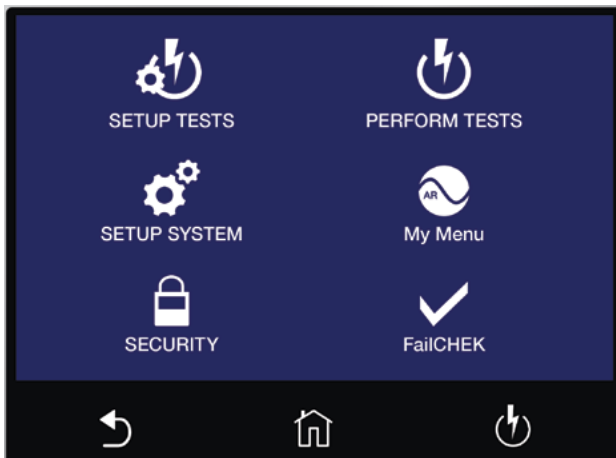

Main Menu

## Getting to Know Your Instrument

### Using the Touch Screen

The touch screen display of the Hypot provides full control of the instrument. Use the touch screen to setup system and test parameters as well as security setup and calibration. Hypot's touch screen functions just like any other touch screen.

### Soft Keys

The Hypot touch screen has 3 functional keys: Back, Home and Perform Tests:

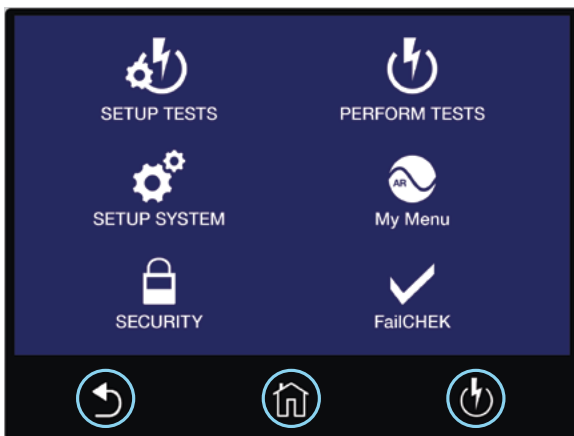

Use the **Back** key to return to a previous menu.



Use the **Home** key to return to the Main Menu.



Use the **Perform Tests** key to navigate to the Perform Tests screen.

## Touch

The various screens of the Hypot will display icons and parameters. Touch the appropriate icon or parameter with the fingertip as shown in the image to the right.

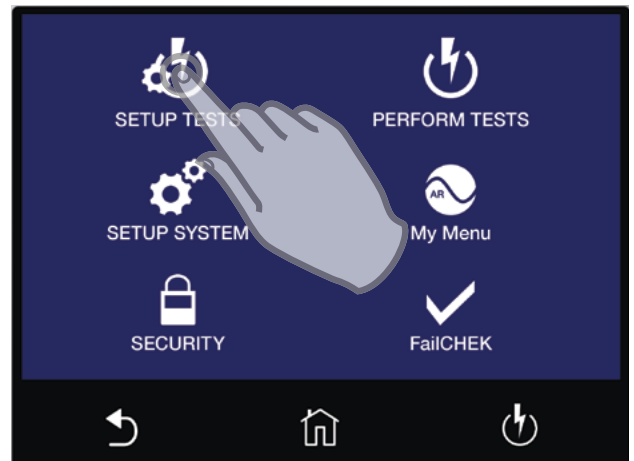

## Scroll and Swipe

A scroll bar on the right side of the screen indicates that there are additional parameters or features. To scroll up and down between parameters touch the screen anywhere scroll upward or downward. Swipe left to right in order to change parameters when setting up test or system values.

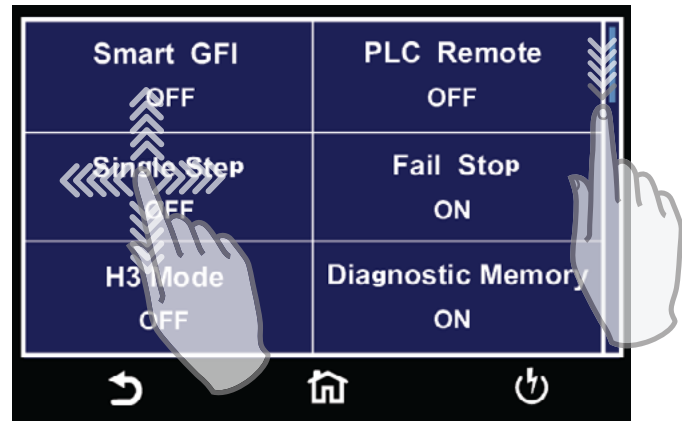

## Drag and Drop

You can drag and drop test files and steps on certain Hypot screens. To use this feature simply touch and hold the test file, test step or parameter. Drag the file to the appropriate location as shown in the following screen to the right.

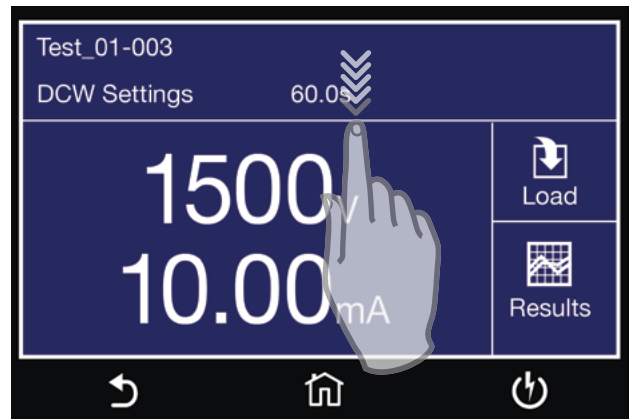

# Main Menu

Upon powering up, the instrument will default to the Main Menu. The Main Menu is also the default home screen.

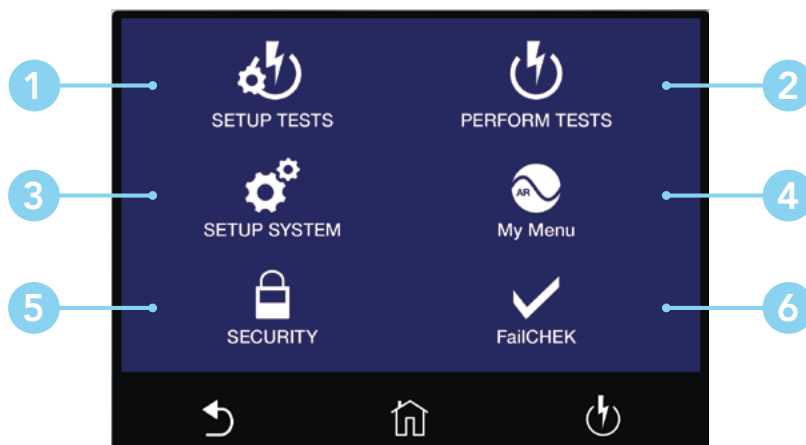

Main Menu

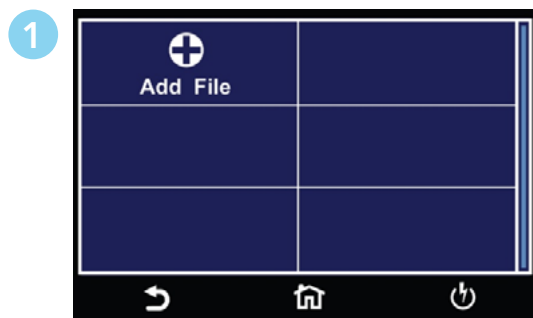

Setup Tests Screen - Create test files.

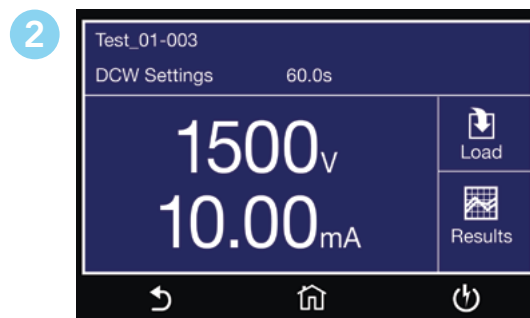

Perform Test Screen - Navigate to the Perform Tests screen in order to run a test sequence.



Setup System Menu - Instrument global parameters such as time and date, calibration and hardware.



My Menu Screen - User customized menu.

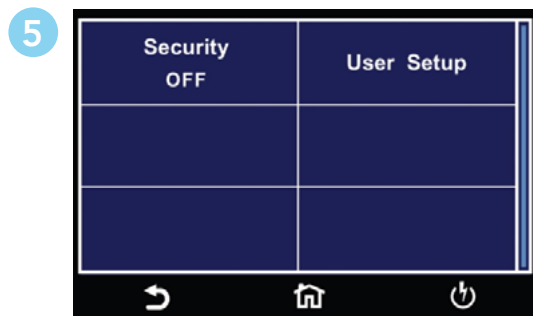

Security Menu - Access instrument lockout and security features.



FailCHEK Menu - Check the instrument's failure detectors

**\*Note – Details of each system and test parameter are listed in the relevant sections of the manual.**

# 1. Setup System

From the default main menu touch the Setup System icon to enter the Setup System sub menu. This is where all System Parameters can be edited:

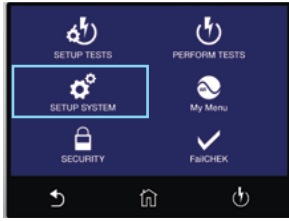

Time and Date Menu

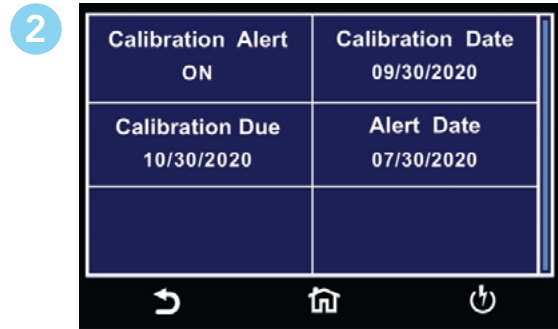

Calibration Alert Menu

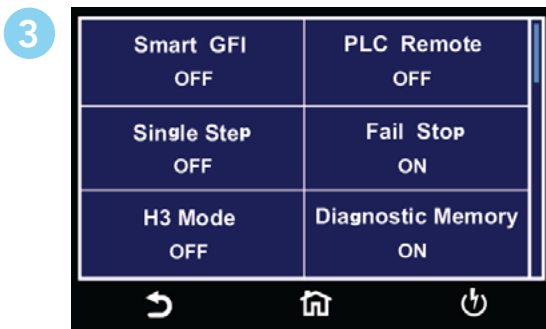

Hardware Menu



User Interface Menu

Continued on next page →

## Setup System Continued

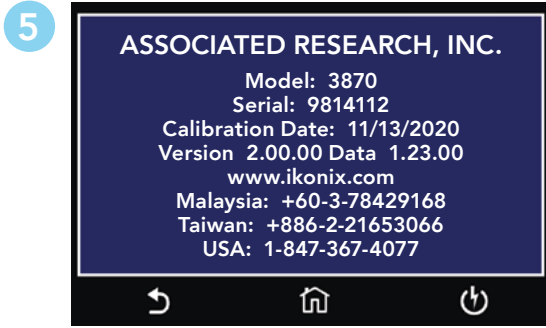

Information Screen



[Import/Export](#) Menu

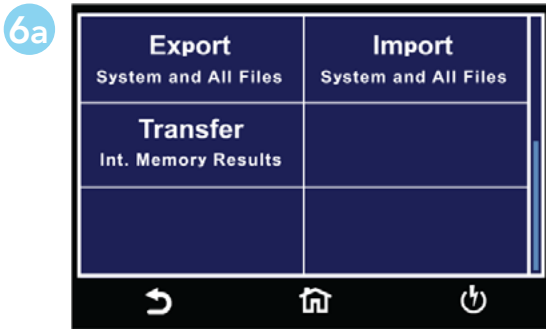

[Import/Export](#) Menu 2

## Time and Date

Time and Date menu allows the user to edit and save the System Time and Date. This time and date will be used to stamp the test results data.

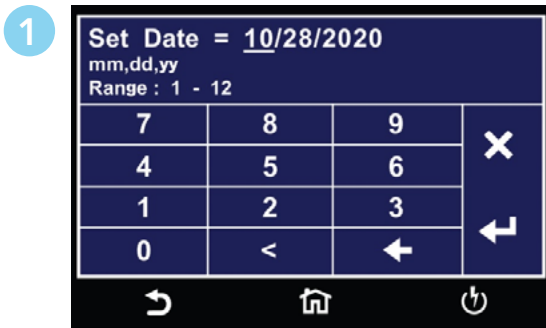

Enter the current date to set System Date.

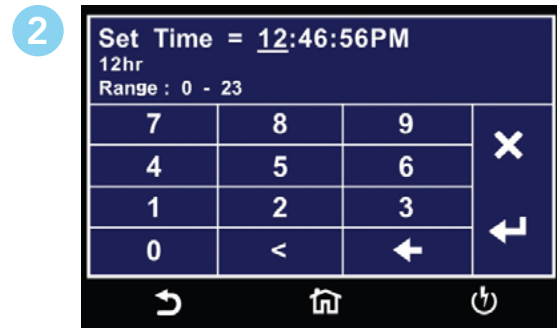

Enter current time to set System Time.

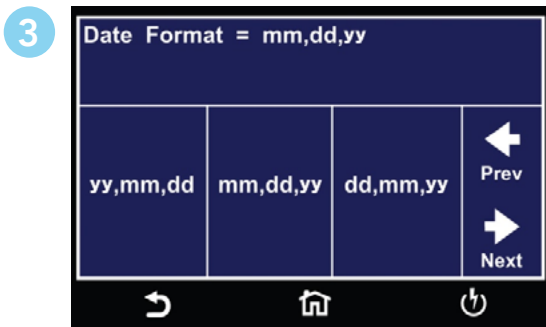

Select the Date Format for System Date.

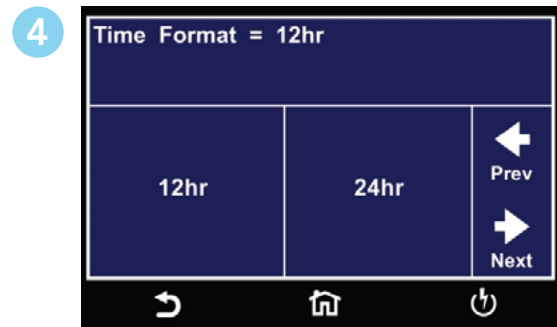

Select the Time Format for System Time.



## Calibration Alert

The Calibration Alert menu allows the user to setup alerts prior to the Calibration Due date. The user can also edit the Calibration Due date. It is not recommended that the Calibration Due date be changed once the instrument has been calibrated. Associated Research recommends annual calibrations for all models.

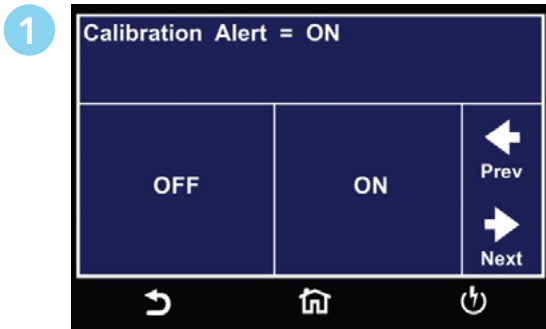
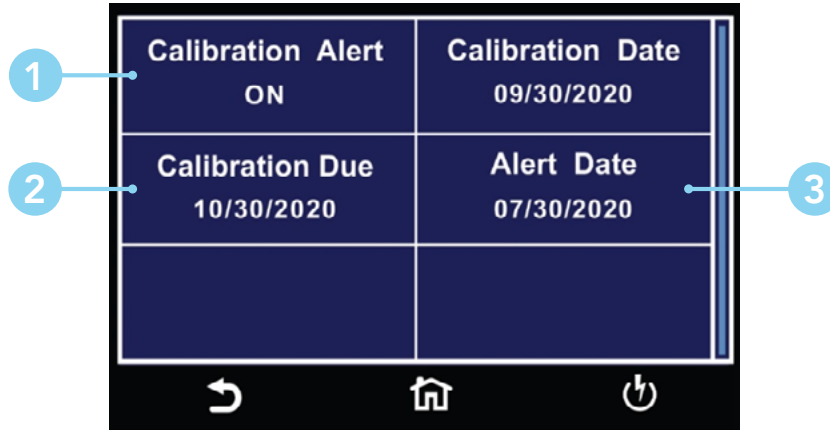

Select Calibration Alert ON or OFF.

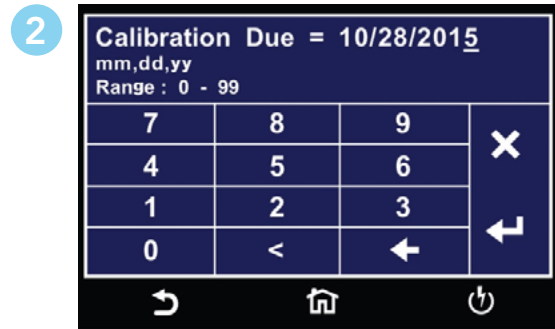

Enter a Calibration Due date.

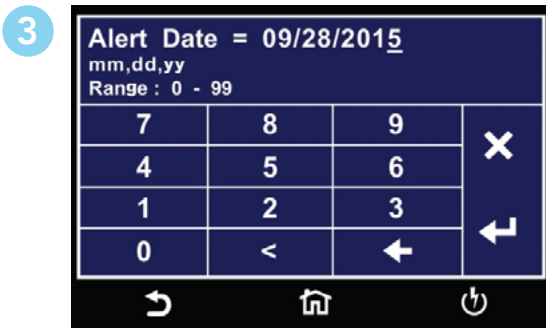

Enter a Calibration Alert Date.



The above Calibration Alert screen will be displayed upon powering up the instrument, on and after the Calibration Alert Date. This screen will display the Calibration Due Date of the instrument.

## Information Screen

The Information screen displays all instrument information including: Model Number, Serial Number, Calibration Date, Company Information and Firmware Version.



## User Interface

The User Interface menu allows the user to edit Results, Touch Sound, Alarm Volume, Language, Home Screen & Color Style parameters.

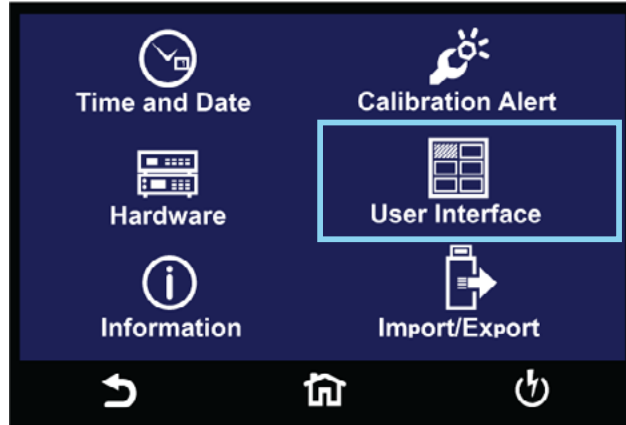

Setup System Menu



User Interface Menu

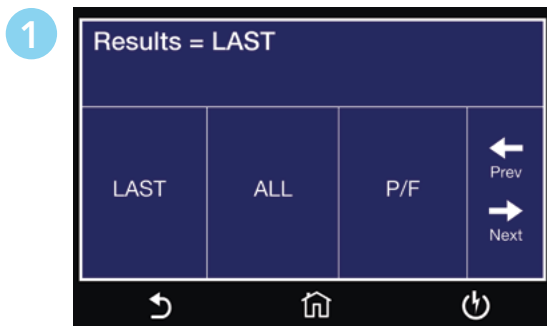

Select end of test [Result](#) Screen.

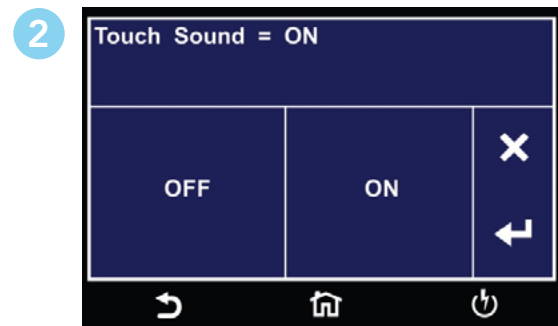

Select [Touch Sound](#) ON or OFF.

Continued on next page →

## User Interface Continued

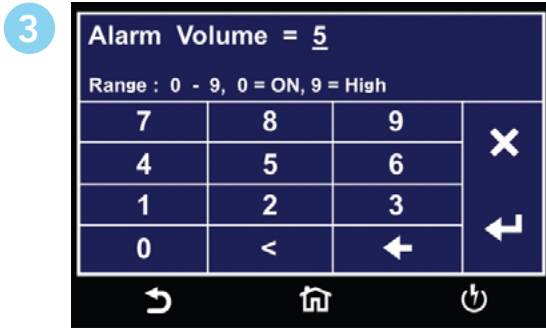

Enter Alarm Volume level.



Select System Language.

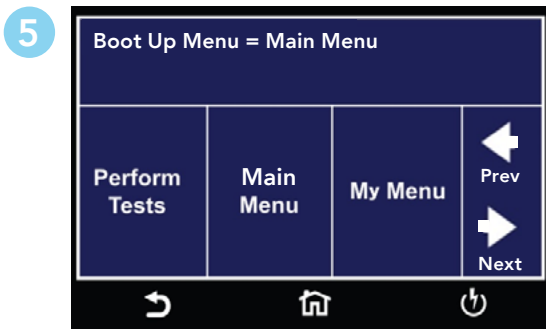



Select start up Home Screen.



Select System Color Style.

## User Interface Parameter Descriptions

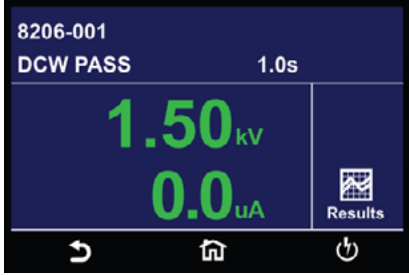
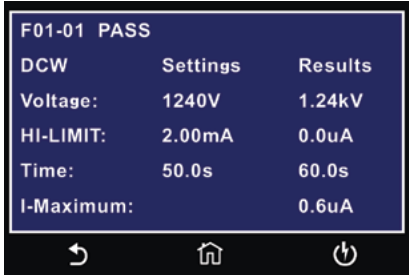
Descriptions of User Interface parameters are listed in the following table:

RESULT	Select how the test results will be displayed at the end of a test or test sequence.																				
	LAST	The results of the last step performed will be displayed on the Perform Tests screen. There will not be a change in appearance or special screen displayed in this mode.																			
	ALL	Results summary screen will be displayed at the end of the test or sequence of connected steps displaying the results of all of the steps.	 <table border="1" data-bbox="1024 573 1430 846"> <thead> <tr> <th>F01-01</th> <th>Settings</th> <th>Results</th> </tr> </thead> <tbody> <tr> <td>DCW</td> <td></td> <td></td> </tr> <tr> <td>Voltage:</td> <td>1240V</td> <td>1.24kV</td> </tr> <tr> <td>HI-LIMIT:</td> <td>2.00mA</td> <td>0.0uA</td> </tr> <tr> <td>Time:</td> <td>50.0s</td> <td>60.0s</td> </tr> <tr> <td>I-Maximum:</td> <td></td> <td>0.6uA</td> </tr> </tbody> </table>	F01-01	Settings	Results	DCW			Voltage:	1240V	1.24kV	HI-LIMIT:	2.00mA	0.0uA	Time:	50.0s	60.0s	I-Maximum:		0.6uA
F01-01	Settings	Results																			
DCW																					
Voltage:	1240V	1.24kV																			
HI-LIMIT:	2.00mA	0.0uA																			
Time:	50.0s	60.0s																			
I-Maximum:		0.6uA																			
	P/F	Pass or Fail screen will be displayed at the end of the test.																			
Touch Sound	Set the instrument to emit a short audible beep anytime the screen is touched. Select between ON or OFF.																				
Alarm Volume	Set the instrument alarm volume. The numbers corresponding to the different volume settings are 0 through 9, 0 meaning the volume is off, and 9 being the loudest setting.																				
Language	Set the instrument display in the desired language. The available languages on the Hypot instruments are English, Chinese, Simplified Chinese, German, French, Turkish, Portuguese, Japanese and Spanish.																				
Boot Up Menu	Set the default screen upon instrument power up. Choose between Perform Test, Menu or My Menu.																				
Color Style	Set the color style of the touch screen.																				

## Import/Export

Insert USB disk into Data port and the following screen will appear. Select Import/Export to use the Import/Export menu to transfer data. Select Result Data to go to Result Data settings menu. Please refer to the Results Data section of this manual.

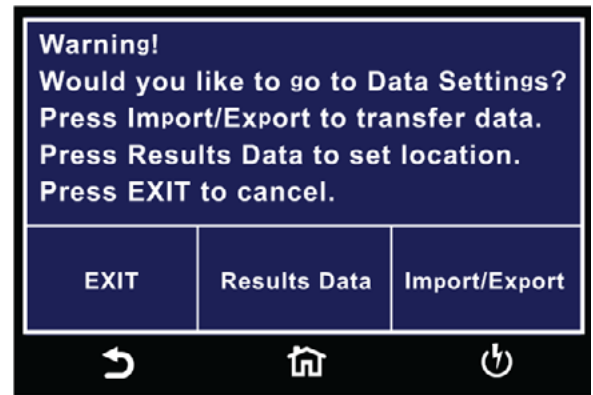

The Import/Export menu allows the user to import or export System and Test Files from a USB flash drive into the instrument memory. The Import/Export menu will only appear under the Hardware menu if a USB flash drive is inserted into the Data port on the front panel of the instrument.



Setup System Menu



Import/Export Menu



Import/Export Menu

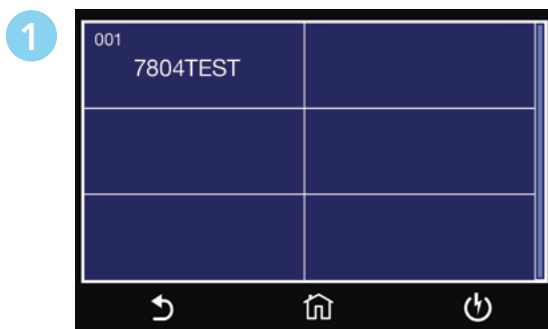

Select the Test File to export.

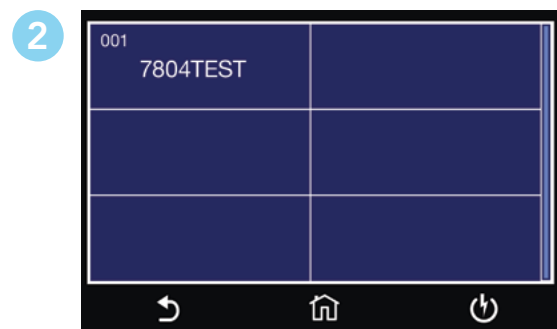

Import a single Test file.

Continued on next page →

## Import/Export Continued



Enter file name for exporting All Files.

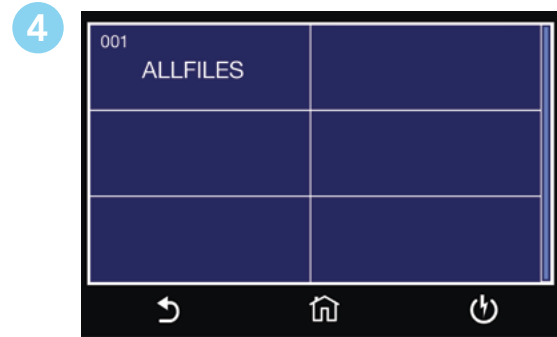

Import all Test files.

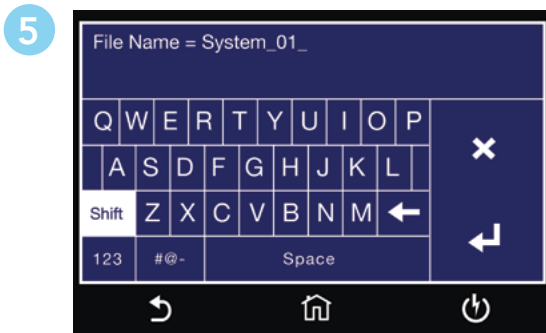

Enter file name for exporting System File.

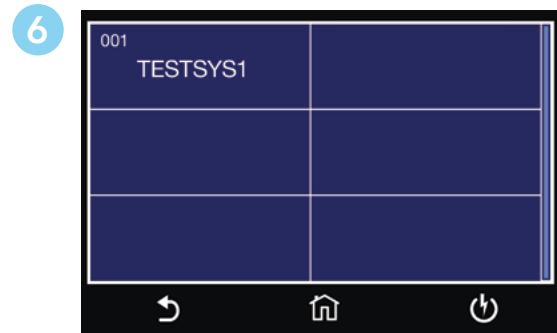

Import System file.

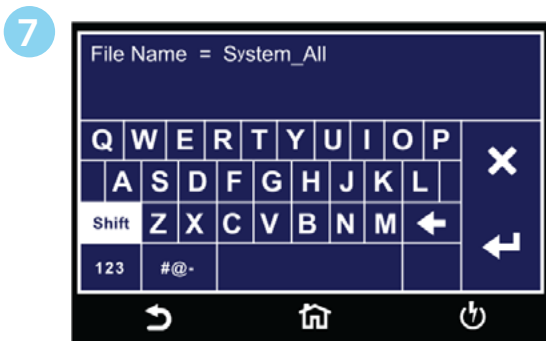

Enter file name for exporting System and All Files.

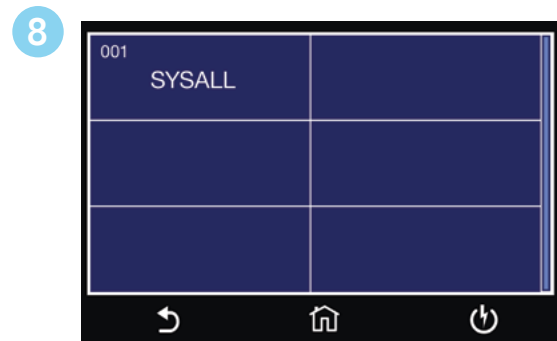

Import System and all Test files.

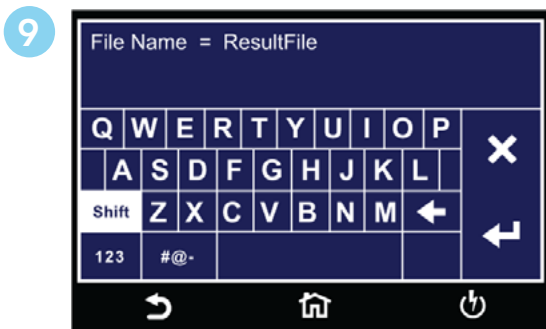

Enter file name for exporting results from internal memory.

With Result Setup Location set to Int. Memory, Transfer can be used to export result data stored on the internal memory. The number displayed shows total number of available results stored on internal memory.

# Hardware

The Hardware menu allows the user to setup hardware parameters.

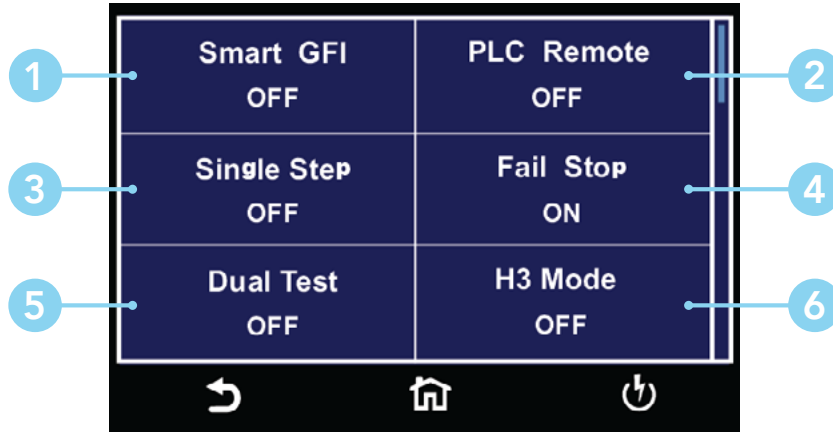

Hardware Menu

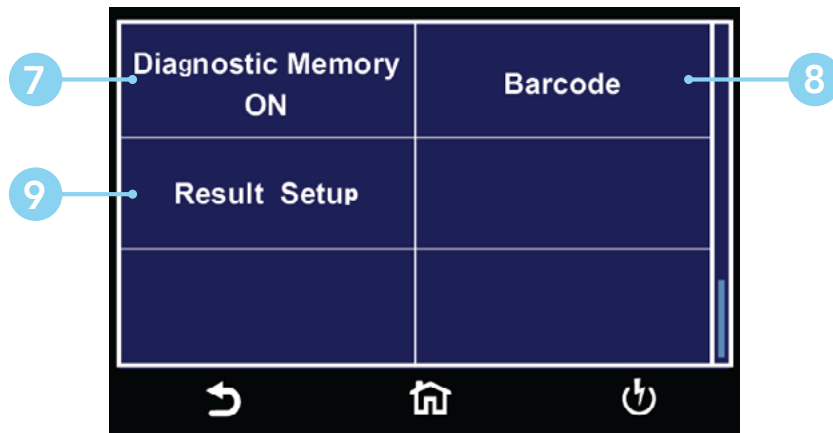

Hardware Menu Cont.

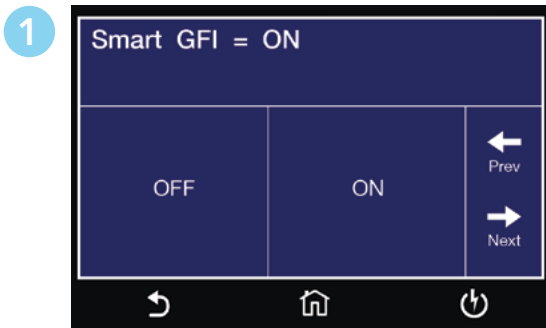

Enter [SmartGFI](#) value.

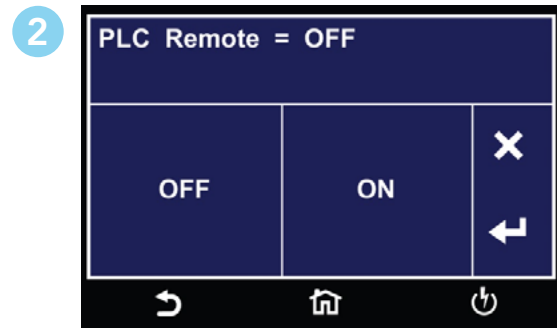

Select [PLC Remote](#) ON or OFF.

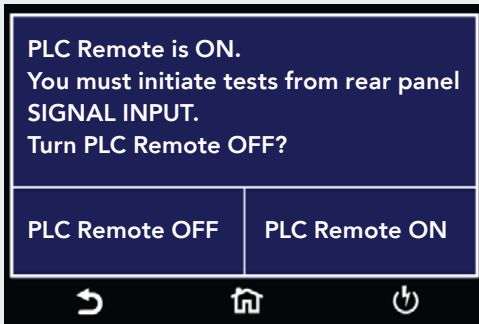

This screen comes up when pressing TEST button while PLC is ON warning customer to adjust PLC setting if need to use the TEST button.

Continued on next page →



## Hardware Continued

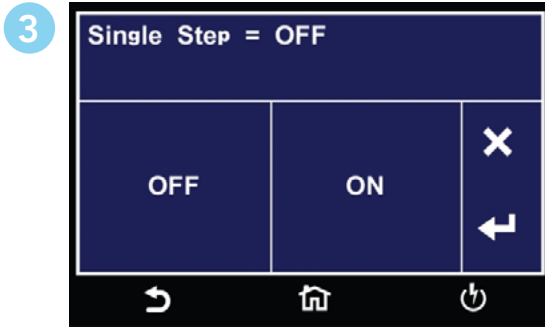

Select **Single Step** ON or OFF.

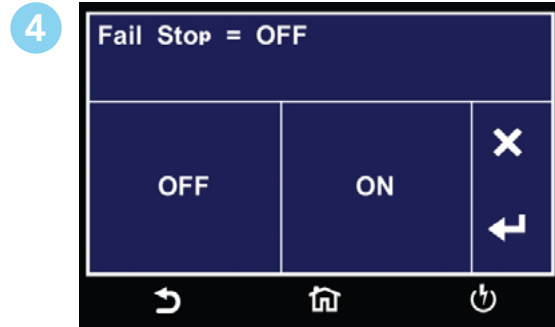

Select **Fail Stop** ON or OFF.

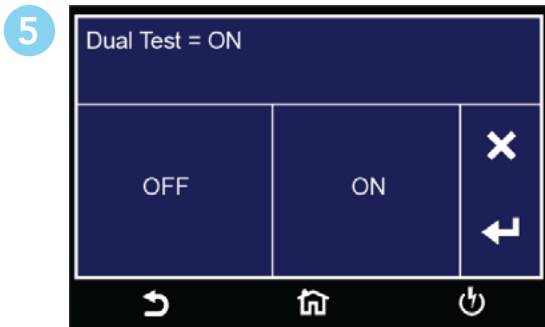

Select **Dual Test** ON or OFF for Dual Remote Palm Switches.

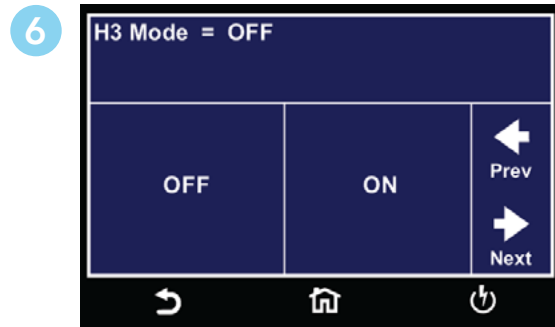

Select **H3 Mode** ON or OFF.  
(Discontinued Option)

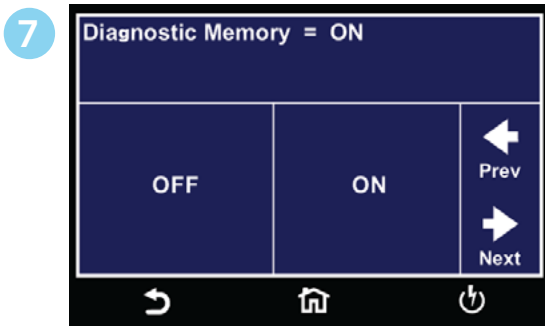

Select **Diagnostic Memory** ON or OFF.

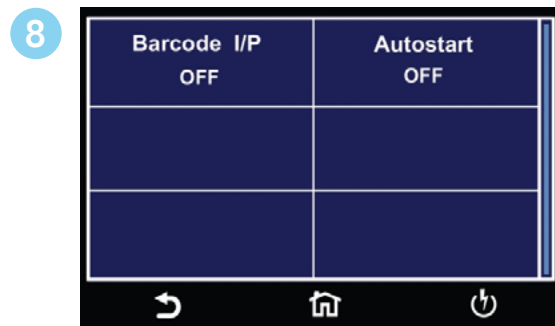

Barcode Menu.

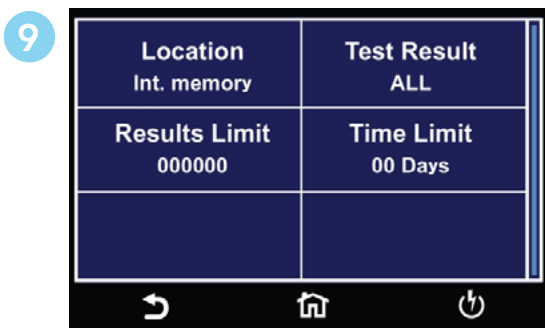

Results Setup Menu.

## Hardware Parameter Descriptions

Descriptions of Hardware parameters are listed in the following table:

System Parameter	Setting	Description
<b>Smart GFI</b>	ON/ OFF	<p>The high voltage power supply of the Hypot is internally referenced to earth ground. Since the leakage current measuring circuit of the instrument monitors only current that flows through the return lead the possibility exists for current to flow directly from the high voltage output to earth ground without being measured. The SmartGFI (Ground Fault Interrupt) circuit monitors the current between the high voltage output and earth ground. Therefore, if you touch the high voltage lead and earth ground, the instrument will detect this hazardous condition and shut off immediately.</p> <p>SmartGFI goes beyond a standard GFI circuit by automatically determining the return configuration of the DUT (grounded or floating) and enabling or disabling depending on the situation. When the Hypot's Return lead is floating, the SmartGFI circuit enables, protecting the test operator from electric shock. When the Hypot's Return lead is earth grounded, the SmartGFI circuit disables and the instrument operates in a grounded return mode of operation. If the GFI were to remain active in this state, the instrument would continuously fail since all current is returning through earth ground. By disabling the SmartGFI circuit and operating in a grounded return mode, Hypot allows the user to perform tests on devices that have their chassis's earth grounded by the test fixture or test environment.</p>
<b>PLC Remote</b>	ON/ OFF	Allows the user to initiate a test through the REMOTE INPUT on the rear panel of the instrument. If PLC Remote = ON the front panel TEST button is disabled and a test may only be started through the rear panel Remote I/O. If PLC Remote = OFF, the test must be initiated via the front panel TEST button.
<b>Single Step</b>	ON/ OFF	If Single Step = ON the instrument will pause after each step is completed. To continue the test sequence, press the TEST button to execute the next connected step. Each time the TEST button is pressed the next connected step will execute. If you press the RESET button before completing all connected steps, it will return the instrument to the original starting step. If a step fails and you wish to continue to the next step, do not press the RESET button but press the TEST button.
<b>Fail Stop</b>	ON/ OFF	If Fail Stop = ON, a sequence of tests will stop if a failure occurs. If Fail Stop = OFF, the sequence of tests will continue to the end of the sequence regardless of whether or not a failure has occurred. If a failure has occurred, the red RESET button will light and alarm will sound indicating failure during the sequence. Pressing the RESET button will silence the alarm and reset the instrument.
<b>Dual Test</b>	ON/ OFF	The Dual Remote Test Switch option allows you to configure dual palm switches for safe production line operation. Both PLC Remote and Dual Test must be ON in order for dual remote test switch operation below to work. The rear panel remote interface is reconfigured to allow two test switches instead of the standard reset and test inputs. The two test switches have to be pressed within 0.5 seconds to activate the test process. The two test switches must remain closed to continue the test. If either of the test switches is released, the process will be shut down immediately. The functions of the Test and Reset switches on the front panel will be disabled if the dual test switches are enabled. When the Dual Test parameter is turned OFF, the Test and Reset switches on the front and rear panel behave the same as the standard instrument, and are controlled by the PLC Remote On/Off selection.
<b>H3 Mode (Discontinued)</b>	ON/ OFF	Optional - The mimic H3 command set option (Discontinued) for Hypot allows to emulate the BUS remote commands that were previously used on Hypot III instrument. The full list of commands can be found in Hypot III manual.
<b>Diagnostic Memory</b>	ON/ OFF	The Diagnostic Memory is a feature that keeps snap-shot records of the tests that the instrument performs. It has a limited capacity to record basic information from test results (up to 4000 results), as well as a capacity to keep running totals for the instrument; number of ACW/DCW/IR tests performed, number of ACW/DCW/IR tests passed, total amount of time the instrument is outputting voltage, etc. These numbers are used by our marketing team to get a rudimentary idea of how our customers are using the instruments as well as help us troubleshoot any possible issues if the instrument comes back for repairs. This is a user-selectable feature and can be enabled or disabled from the Hardware Menu of the instrument.

The table below shows a full list of information that will be recorded if the Diagnostic Memory is enabled:

Information Recorded	Description
<b>Running Totals</b>	Total time duration the output is ON
	Total time duration the instrument is ON
	Total number (summation) of all tests performed
	Total number of ACW tests performed
	Total number of DCW tests performed
	Total number of IR tests performed
	Total number of ACW Pass
	Total number of DCW Pass
	Total number of IR Pass
	Number of times FailChek is used
<b>Test Results</b>	Number
	Date
	Time
	Test Type (ACW/DCW/IR)
	Status (PASS/FAIL/ABORT)
	Voltage
	Current/Resistance
	I-max
	Dwell Time
	Frequency
<b>Settings</b>	Color Style is selected
	Home Screen configuration
	Smart GFI (Yes/No)
	PLC Remote (Yes/No)
	Single Step (Yes/No)
	Fail Stop: y/n
	Remote Bus Active (Yes/No)
	Continuity (Yes/No)
	Prompt (Yes/No)
	Arc Detect (Yes/No)
	Charge-Lo (Yes/No)
	Ramp-Hi (Yes/No)
	Number of test files created/used
Language	

Hypot® comes from the factory with the following system presets:

System Parameters		
Setup Sys.	PLC Remote	OFF
	Single Step	OFF
	Fail Stop	ON
	Alarm	5
	Results	Last
	Smart GFI	ON
	Results	Last
	Cal Alert	ON
	Security	OFF

## Barcode

### Barcode I/P

The Barcode function allows you to connect a barcode scanner directly to the front panel of the instrument's barcode port. This is utilized to enter product and serial number information for testing.

To use this function, plug a USB type barcode reader into the barcode port on the front panel of the instrument. Once a USB barcode is plugged in, the instrument will notify you that a reader has been detected:

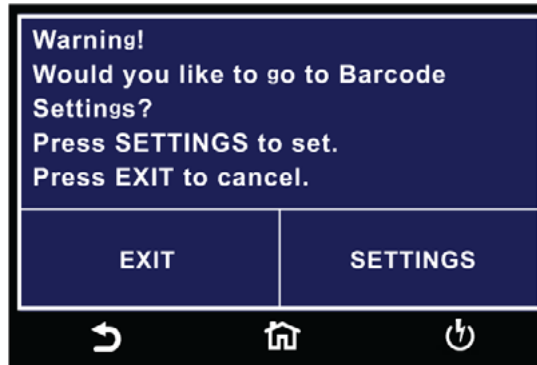

If there is a problem with the connection to the barcode reader or an incompatible device is plugged into the USB barcode port, the following message will appear:

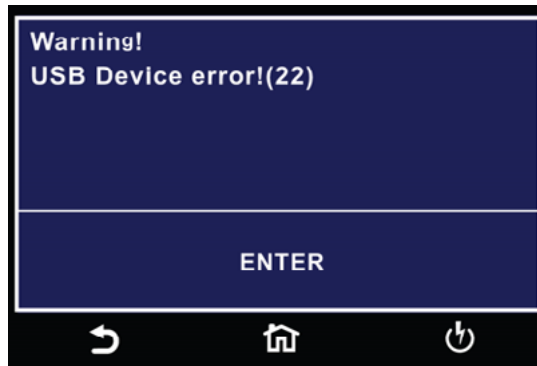

If the USB barcode device is removed while the instrument is powered on, the following message will appear:

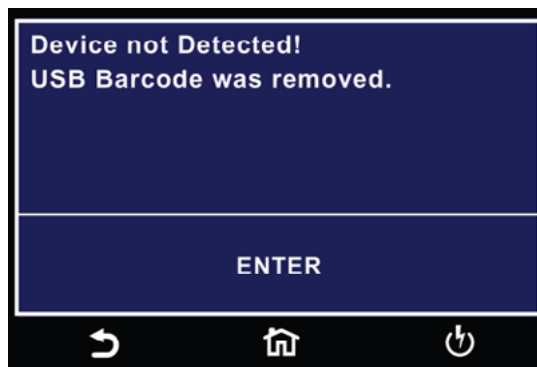

## Important Information regarding the Barcode Feature

There are two options under Barcode, Barcode I/P and Autostart.

You can set the Barcode I/P function to OFF, SER/PROD, SERIAL #, PRODUCT # or RUN FILE.

When the setting is SERIAL#, PRODUCT# or SER/PROD you can scan barcodes in the Perform Tests screen before the test is started.

### Carriage Return (Enter) Function

The barcode scanner needs to be programmed to perform a carriage return function after each scan. A carriage return, also known as the enter key, is used to bring the cursor down or onto the next data field after each scan. Please refer to the barcode manufactures' programming instructions to add "Carriage Return/Enter" at the end of scan.

After the barcodes are scanned, pressing TEST will initiate the test sequence. Pressing RESET will abort the TEST sequence. The barcode function allows for the re-scanning of barcodes if the previously scanned barcode was incorrect. Re-scanning is available in the SERIAL#, PRODUCT# and SER/PROD modes. Any time before a test is initiated; you can re-scan a barcode. If you decide to re-scan barcodes when the Barcode I/P setting is set to SER/PROD, the barcode function will first replace the data in the Serial Number field, and if you re-scan another barcode, the barcode function will replace the data in the Product Number field.

The RUN FILE selection gives you the ability to automatically load a test file based on what barcode is scanned from the Perform Tests screen.

To completely enable this feature, you must name the desired test file for a particular product the exact alpha-numeric code that is on the product's barcode label. For example, if Product A has barcode "12345678", then the test file that you would like to run when testing Product A must be named "12345678". Upon scanning the barcode, the Hypot will immediately load the test associated with that barcode. The test file name is limited to 8 characters. However, if you name a test file with the maximum 8 characters, this function will still initiate a test when a product's barcode begins with those first 8 characters, even if the barcode has more than 8 characters.

### The Maximum Length of the Barcode Model/Serial Number is Limited to 21 Characters

When using certain features of barcoding, the instrument's response to the TD? and RD x? commands will differ slightly to an instrument that is not utilizing this function. For all types of tests (ACW, DCW, IR, CONT) two fields are added to the end of the standard response when the Barcode I/P setting is set to SERIAL#, PRODUCT# or SER/PROD.

The first field contains the Serial Number information and the second field includes the Product Number information. Both fields are included regardless of which of these three modes are selected. The instrument will simply substitute a "0" for the field if it is not applicable to the setting. For example, if a user had their Barcode I/P setting set to SERIAL#, and scanned a Serial Number with the value "12345678", the TD? response for an ACW test could be:

```
01,ACW,Pass,1.24,1.000,0.900,1.0,12345678,0
```

Note that there is a "0" in the Product Number field because the Barcode I/P setting is SERIAL#. When the Barcode I/P setting is RUN FILE or OFF, these fields are not included in the TD? and RD x? responses.

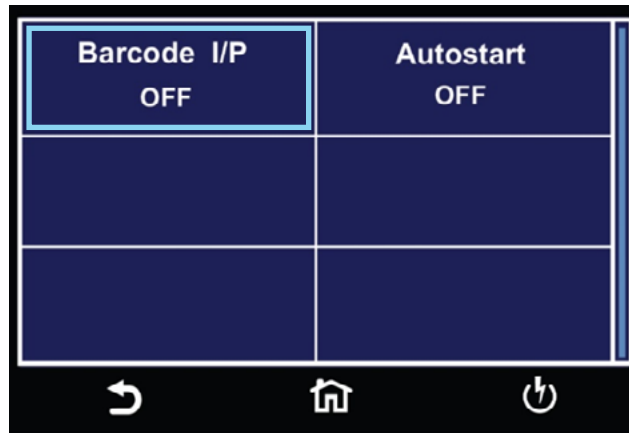

Barcode Menu

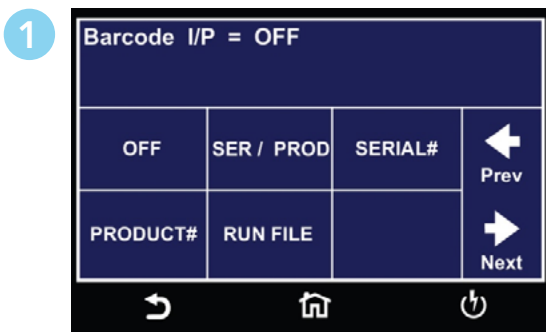

Select Barcode input option.

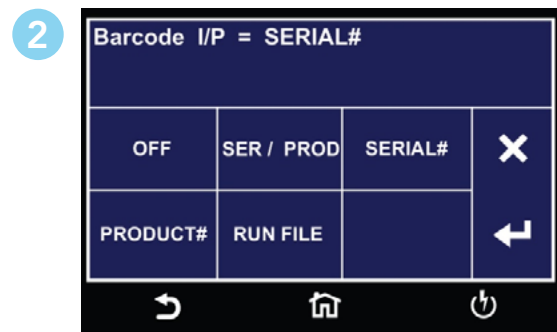

Select Barcode type.

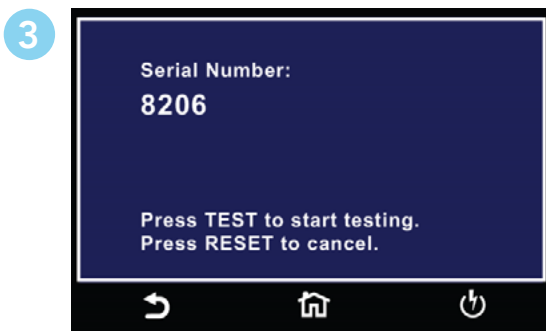

Example SERIAL # screen.

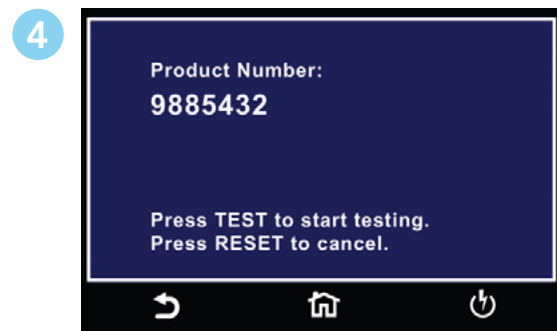

Example PRODUCT # screen.

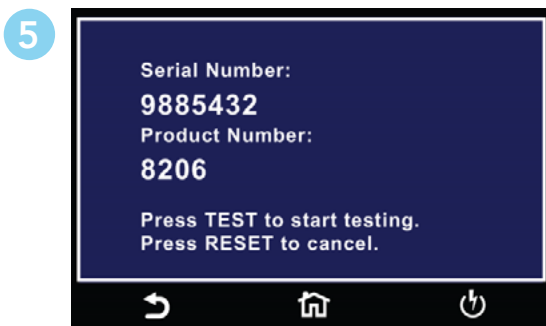

Example SER/PROD screen.

## Barcode Autostart

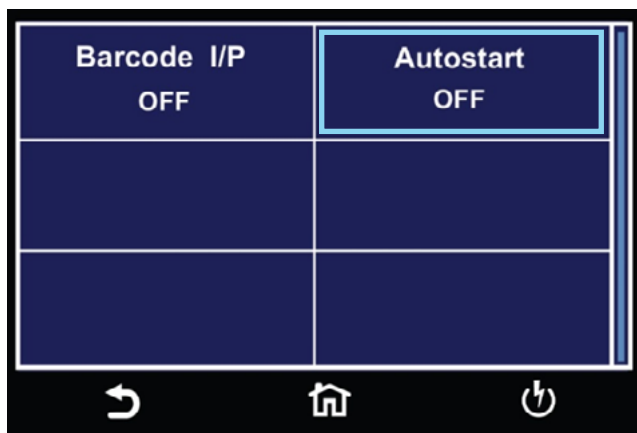

Barcode Menu



Select Autostart ON or OFF.

Mode	Description	Auto Start On/OFF	
<b>Serial / Product</b>	If test filename (CASESENSITIVE) matches the Product Name/Number, the instrument will Auto Load that test file. Test results will store both product and serial number.	<p>ON – Enables the test to be auto started on the second scan of the matching product number. Serial and Product numbers are recorded and included in the results data.</p> <p>Example Steps:</p> <ul style="list-style-type: none"> <li>• Scan Serial Number</li> <li>• Scan Product Number</li> <li>• Scan same Product Number again to start the test.</li> </ul>	<p>OFF – Manually press TEST button to start test.</p>
<b>Serial #</b>	Records the serial number for the currently loaded test file.	N/A	
<b>Product #</b>	If test filename (CASESENSITIVE) matches the Product Name/Number, the instrument will Auto Load that test file. Test results will store both product and serial number.	<p>ON – Enables the test to be auto started on the second scan of the matching product number. Product number is recorded and included in the results data.</p> <p>Example Steps:</p> <ul style="list-style-type: none"> <li>• Scan Product Number or Name</li> <li>• Scan same Product Number or Name again to start the test</li> </ul>	<p>OFF – Manually press TEST button to start test.</p>
<b>Run File</b>	Finds the test file name same as the scanned barcode and loads this test. The test will also auto start once the test is loaded.	N/A	



## Results Setup

Select Int. memory if you wish to store the test results on the onboard instrument memory. Select USB disk if you wish to save the test results on an external USB flash drive. For best results use the USB flash drive provided by Associated Research.

Select PASS to save the results of the steps that passed. Select FAIL to save the results of the steps that failed. Select ALL to save all the test results. Selecting NONE will not save any results to the internal memory.

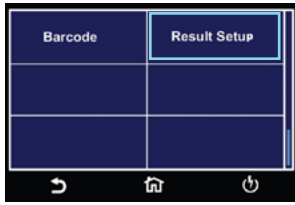

Hardware Menu

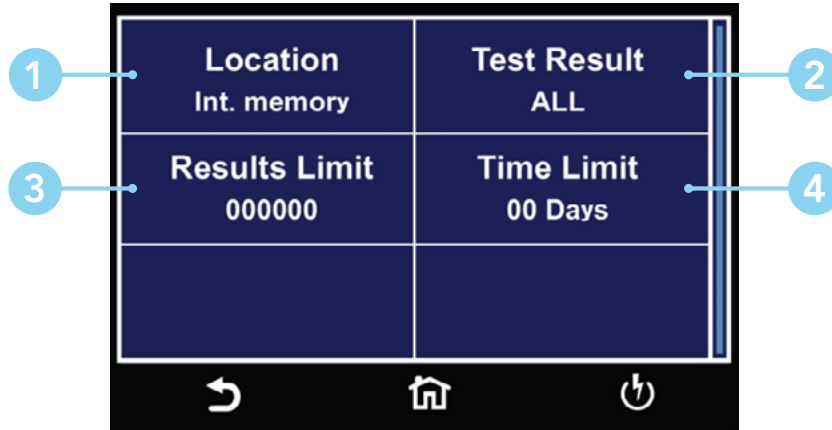

Result Setup Menu

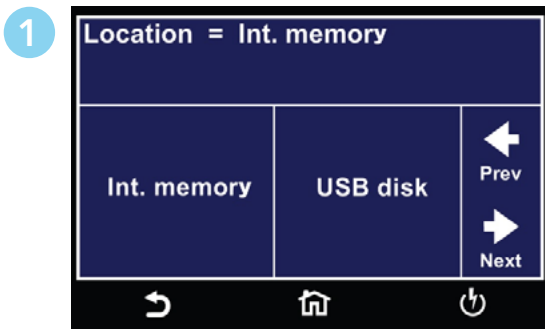

Select Location for Result Data.

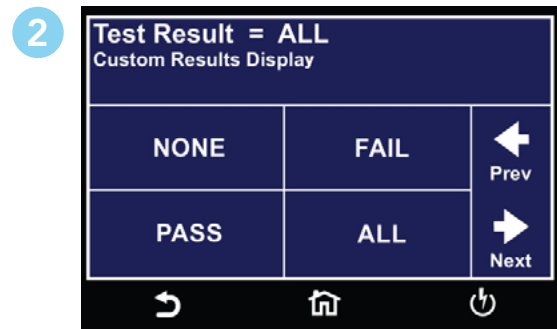

Select type of Test Results to be saved.

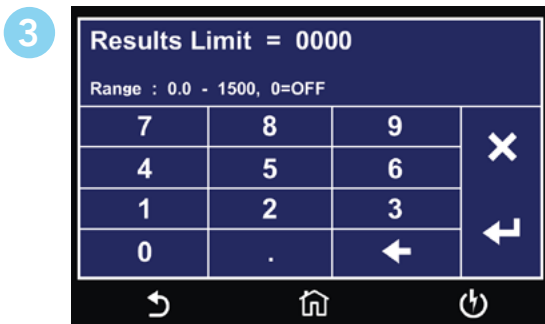

Enter Results Limit.



Enter Time Limit.

You can set the Results Limit. Select from 0 up to 1500 with 0 being OFF. Selecting 0 will set the Results limit to OFF which means you can store as many results as desired until you reach the maximum capability of 1500 results.

## Internal Memory

Insert USB disk into Data port and the following screen will appear. Select Result Data to go to Result Data settings menu. Select Import/Export to use the Import/Export menu to transfer data. Please refer to the Import/Export section of this manual.

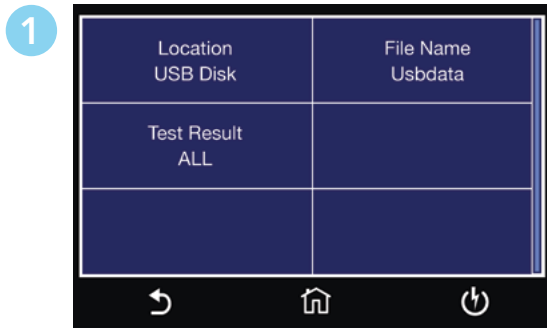
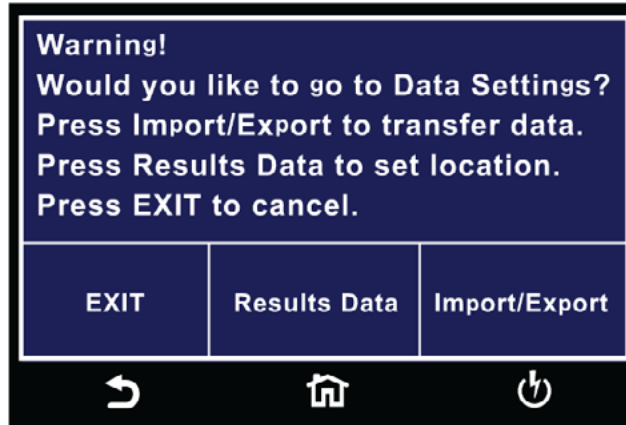

Result Setup USB DISK Menu.

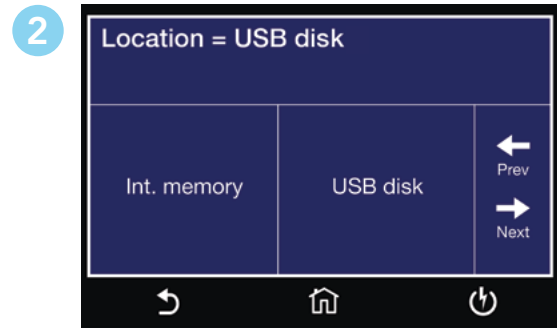

Select Location for Result Data.



Enter File Name.

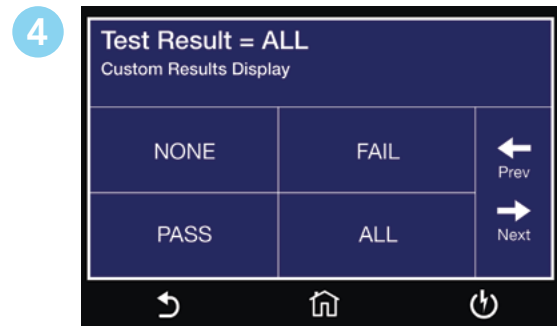

Select type of Test Results to be saved.

## 2. Setup Tests

The following sequence describes the steps necessary to create a test file, program the test parameters and save the test file:



### TAP SETUP TESTS

Home Screen

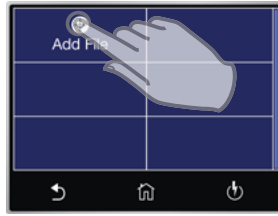

### TAP ADD FILE

File Screen



### ADD FILE NAME (MAXIMUM 8 CHARACTERS)

Tap the ENTER (↵) key to save your selection

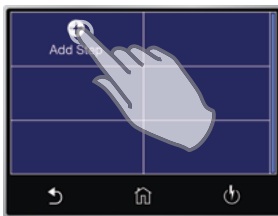

### TAP ADD STEP

Add Step



### TAP TEST SETTING

Tap the test parameter you would like to edit. Swipe up and down to scroll through test parameters.

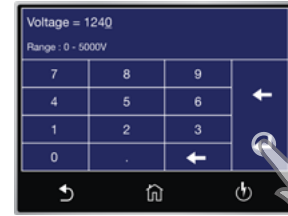

### EDIT PARAMETERS

Tap parameter values to edit individually. After you adjust each parameter, tap ENTER (↵) arrow key to save changes.



### ADJUST PARAMETERS

Scroll through each parameter to adjust values based on your application.

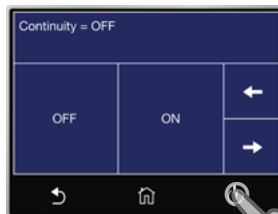

### EXIT PARAMETERS

Press the Test Screen button to exit out of Parameters.

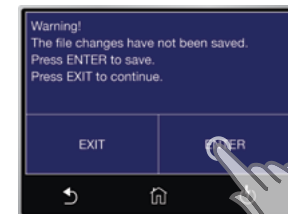

### SAVE FILE CHANGES

Press ENTER to save your file changes. You will be redirected to the Test Screen.

## 2.1 Setup AC Withstand Test

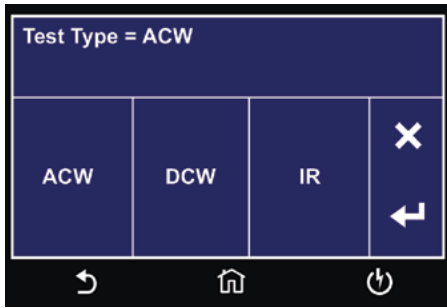

Select ACW Test type.

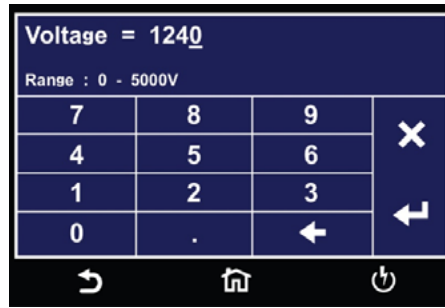

Enter AC test Voltage.

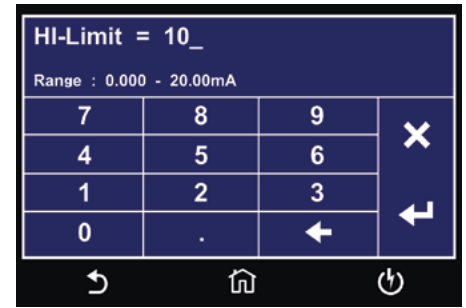

Enter HI-Limit Total.

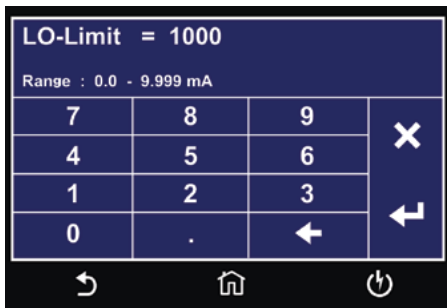

Enter LO-Limit Total.

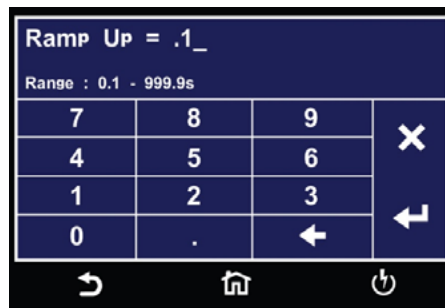

Enter test Ramp Up time.

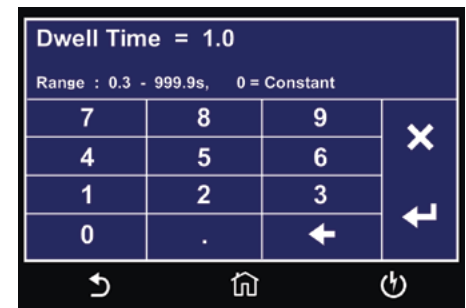

Enter test Dwell time.

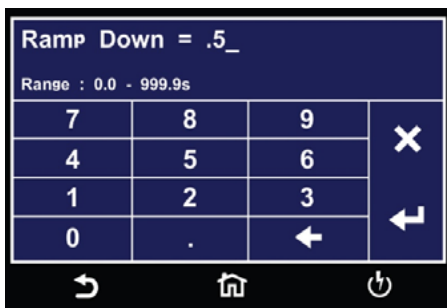

Enter test Ramp Down time.

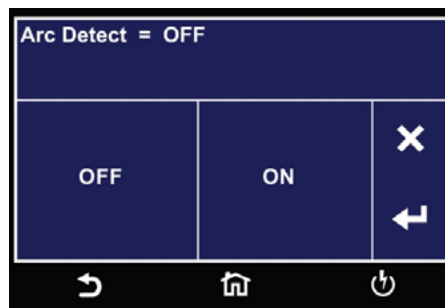

Select Arc Detect ON or OFF.

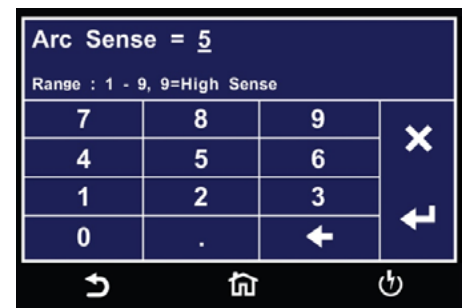

Enter Arc Sense value.

Continued on next page →

## Setup AC Withstand Test Continued

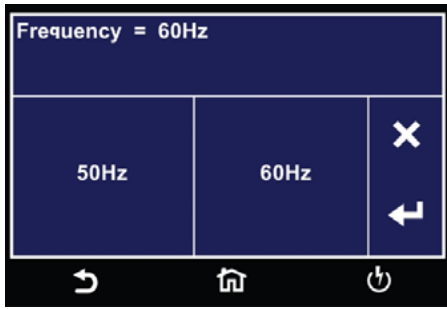

Select test **Frequency**.

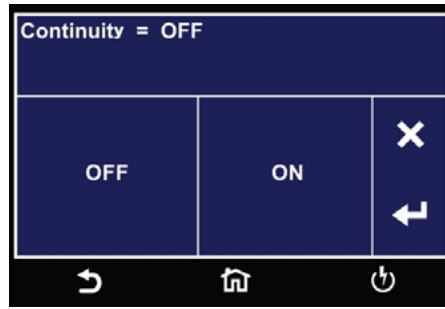

Select **Continuity** ON or OFF.

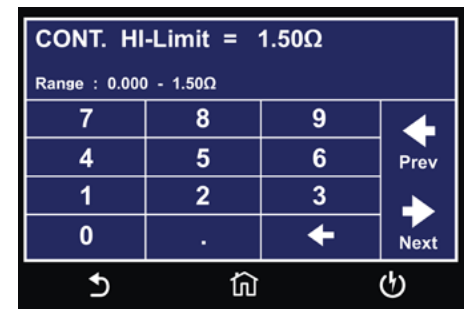

Enter **Cont. HI-Limit** value

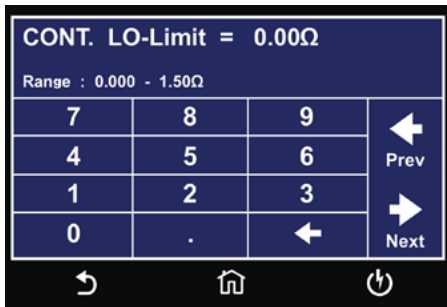

Enter **Cont. LO-Limit** value.

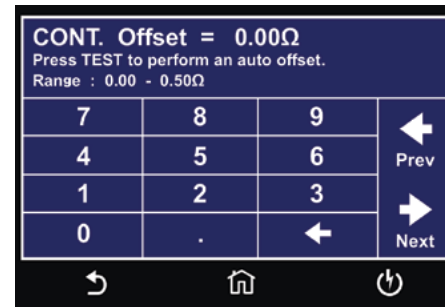

Enter **Cont. Offset** value.

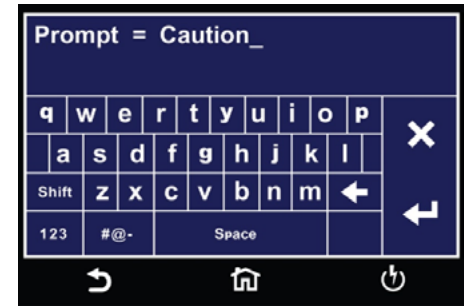

Enter text for **Prompt**.

## 2.2 Setup DC Withstand Test

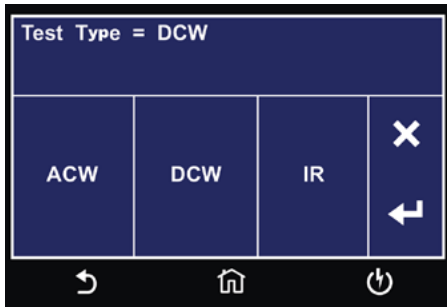

Select DCW Test type.

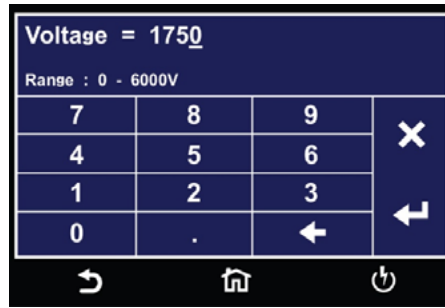

Enter DC test Voltage.

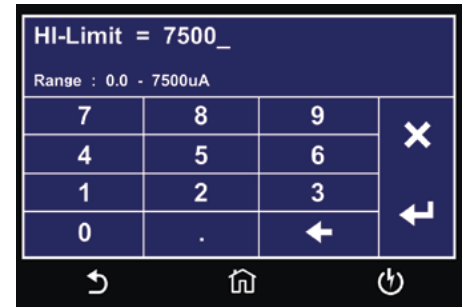

Enter HI-Limit.

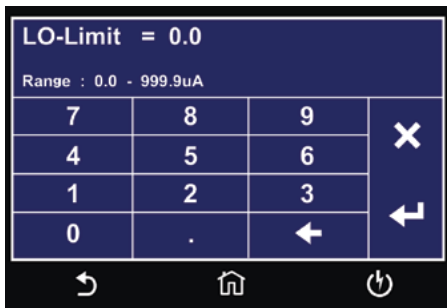

Enter LO-Limit.

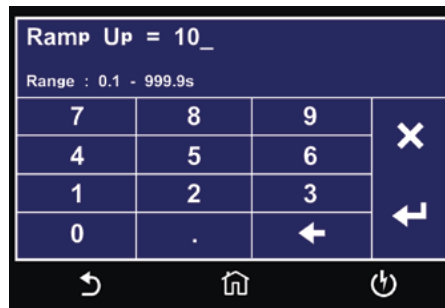

Enter test Ramp Up time.

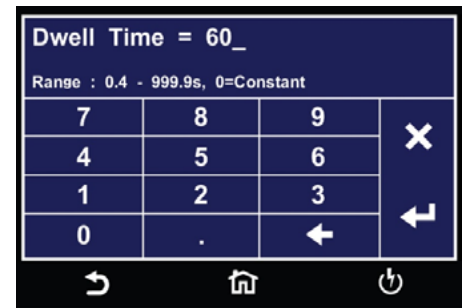

Enter test Dwell Time time.

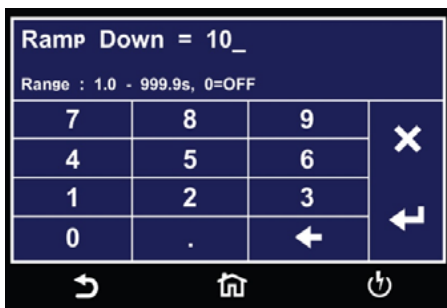

Enter test Ramp Down time.

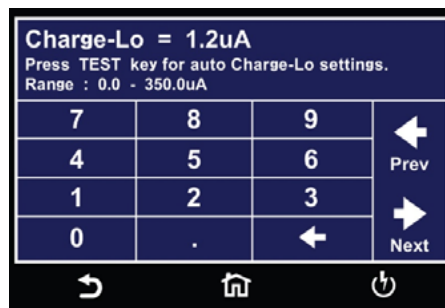

Enter Charge-Lo value to manually set Charge-Lo or Press TEST to perform auto Charge-Lo.

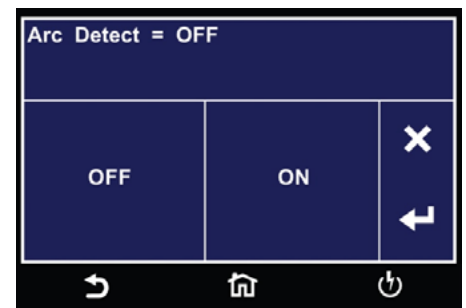

Select Arc Detect ON or OFF.

Continued on next page →

## Setup DC Withstand Test Continued

Arc Sense = 5			
Range : 1 - 9, 9=High Sense			
7	8	9	X
4	5	6	
1	2	3	←
0	.	←	
↶	🏠	🔌	

Enter **Arc Sense** value.

Ramp HI = 0.0uA			
Avoid False Failure			
Range : 0.0 - 7500uA 0 = OFF			
7	8	9	X
4	5	6	
1	2	3	←
0	.	←	
↶	🏠	🔌	

Enter **Ramp-HI** value.

Continuity = OFF		
OFF	ON	X
↶	🏠	🔌

Select **Continuity** ON or OFF.

CONT. HI-Limit = 1.50Ω			
Range : 0.000 - 1.50Ω			
7	8	9	← Prev
4	5	6	
1	2	3	→ Next
0	.	←	
↶	🏠	🔌	

Enter **Cont. HI-Limit** value.

CONT. LO-Limit = 0.00Ω			
Range : 0.000 - 1.50Ω			
7	8	9	← Prev
4	5	6	
1	2	3	→ Next
0	.	←	
↶	🏠	🔌	

Enter **Cont. LO-Limit** value.

CONT. Offset = 0.00Ω			
Press TEST to perform an auto offset.			
Range : 0.00 - 0.50Ω			
7	8	9	← Prev
4	5	6	
1	2	3	→ Next
0	.	←	
↶	🏠	🔌	

Enter **Cont. Offset** value.

Prompt = Caution_												
q	w	e	r	t	y	u	i	o	p	X	←	
a	s	d	f	g	h	j	k	l				
Shift	z	x	c	v	b	n	m	←	←			
123	#@-	Space										
↶	🏠	🔌										

Enter text for **Prompt**.

## 2.3 Setup Insulation Resistance Test

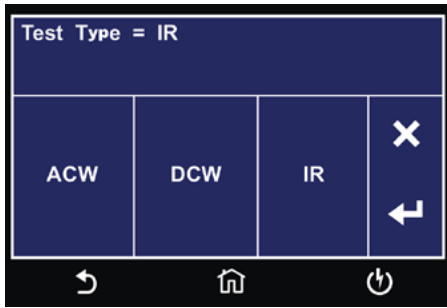

Select IR Test type.

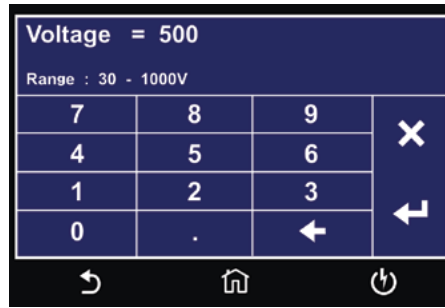

Enter IR test Voltage.

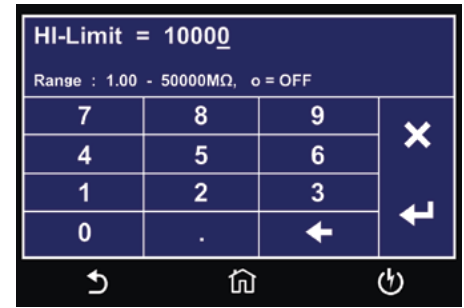

Enter HI-Limit.

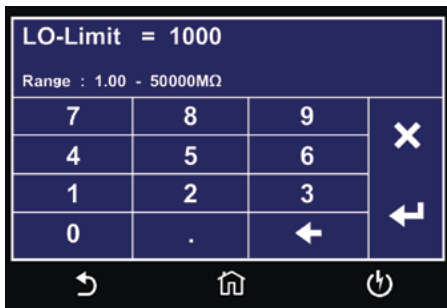

Enter LO-Limit.

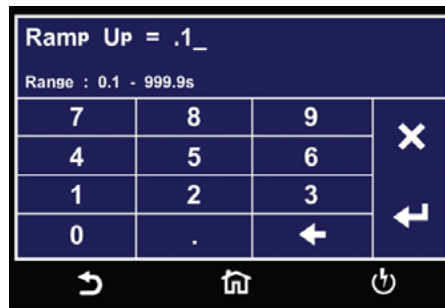

Enter test Ramp Up time.

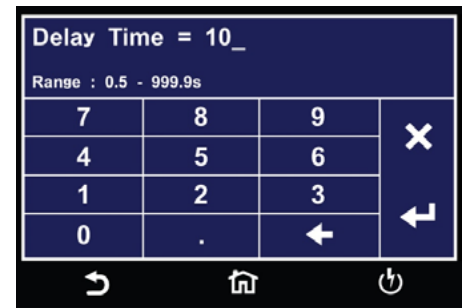

Enter test Delay Time.

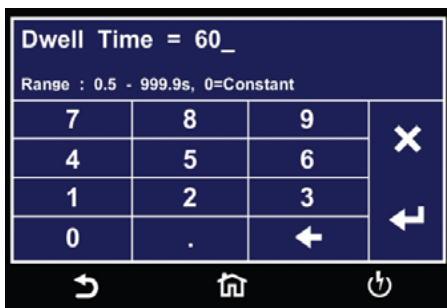

Enter test Dwell Time.

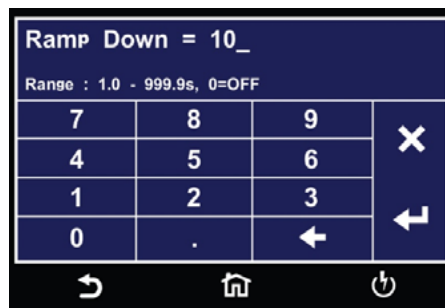

Enter test Ramp Down time.

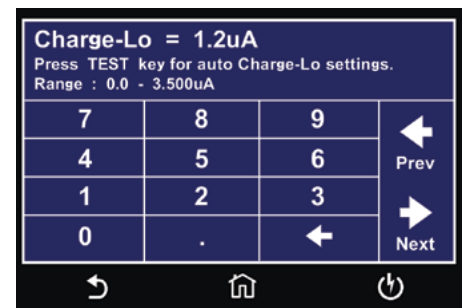

Enter Charge-Lo value to manually set Charge-Lo or Press TEST to perform auto Charge-Lo.

Continued on next page →



## Setup Insulation Resistance Test Continued

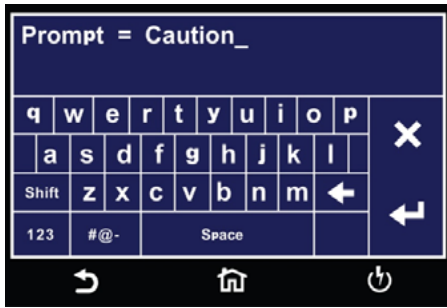

Enter text for [Prompt](#).

## Test Parameters Description

Test Parameter	Test Type	Description
Voltage	ACW, DCW, IR	The voltage that is applied to the high voltage and return terminals during a test.
HI-Limit	ACW, DCW, IR	The maximum current or resistance threshold that triggers a failure when exceeded.
LO-Limit	ACW, DCW, IR	The minimum current or resistance threshold that triggers a failure when not exceeded.
Ramp Up	ACW, DCW, IR	The length of time that is allowed for the test voltage to climb from 0 to the programmed test voltage.
Dwell Time	ACW, DCW, IR	The length of time that is allowed for the programmed test voltage to be applied.
Delay	IR	The length of time that the programmed test voltage is applied but no judgment of the set parameters is made. Judgment of the parameters is not made until the end of the delay time.
Ramp Down	ACW, DCW, IR	The length of time that is allowed for the test voltage to decay from programmed test voltage to 0.
Charge-LO	DCW, IR	<p>Use the Charge-LO function to check if the cables are connected properly at the beginning of a test. A capacitive DUT will draw charging current on the DC Withstand test when the Output is activated. If the charging current is lower than the setting, the test cables may not be connected properly. The instrument can set the Charge-LO parameter manually or automatically. To manually set the Charge-LO current, use the touchscreen keypad to enter the value. To automatically set the Charge-LO current select the Charge-LO parameter and connect all test leads to the DUT as you would when performing an actual DCW test. Press the TEST button on the front panel of the instrument.</p> <div style="border: 1px solid black; padding: 5px; margin: 10px 0;"> <p><b>CAUTION</b> Please be aware that the program will activate high voltage on the output connector while the TEST button is pressed.</p> </div> <p>S'il vous plaît soyez conscient que le programme va activer haute tension sur le connecteur de sortie tandis que le bouton TEST est pressé</p> <p>The program will read the charging current of the DUT and set the Charge-LO current at approximately one half (1/2) of the reading. The instrument will beep and the new value will automatically be updated in the field. You do not need to select the ENTER key for the new parameter to be accepted.</p>

Continued on next page →

## Test Parameters Description Continued

Test Parameter	Test Type	Description
Ramp-HI	DCW	The Ramp-HI function is active during the Ramp period only. Ramp-HI will allow current higher than the normal HI-Limit current setting of the DC Withstand Voltage test to avoid false failure due to charging current.
Arc Sense	ACW, DCW	The maximum allowable threshold for arcing. The numbers 1 through 9 correspond to the different arc sensitivity levels, 1 meaning the maximum threshold of allowable arcing and 9 meaning the minimum threshold of allowable arcing. Arc detection is not required for testing.
Frequency	ACW	The frequency of the applied voltage or current. Select between 50 and 60 Hz.
Offset	Continuity	<p>Used to factor out resistance due to test leads or test fixture. Set manual or measure automatically. To automatically set an Offset value, set the output voltage, current, and frequency to the values you will use on the DUT and connect the test cables, test fixture, or with fixturing to the instrument. Next, for the Continuity test, short the ends of the test cables and press the TEST button. The instrument will beep and automatically update the new value in the field. You do not need to select the ENTER key for the new parameter to be accepted.</p> <div style="border: 1px solid black; background-color: #FFD700; padding: 5px; display: inline-block; margin-bottom: 10px;"> <b>CAUTION</b> </div> <p>Please be aware that the program will activate high voltage on the output connector while the TEST button is pressed.</p> <p>Note: Do not connect the DUT to the instrument when performing an offset. This will create erroneous results when you perform a test.</p>
Prompt	All	The Prompt function allows you to insert a short line of text in a step. The Prompt will appear on the screen before the step is initiated and remains on the screen until you press the TEST button. After you press the TEST button, the Prompt will clear and the step will initialize.

## View Test Files

Once you have programmed and saved all tests, navigate to the Main Menu. Select the Setup Tests icon and select the test file that you previously created. The screen should display all tests that you have programmed in this test file. For example:

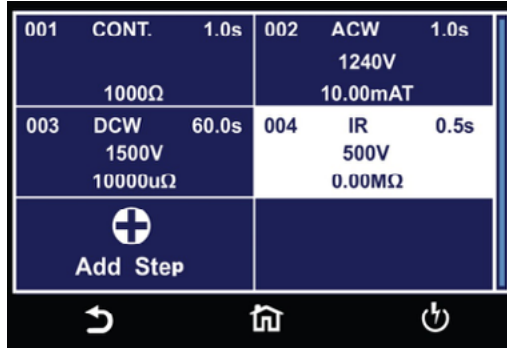

001	CONT.	1.0s	002	ACW	1.0s
				1240V	
		1000Ω		10.00mAT	
003	DCW	60.0s	004	IR	0.5s
		1500V		500V	
		10000uΩ		0.00MΩ	
				+	
				Add Step	

## Edit Test Files

Once you have programmed and saved all test files you can edit these files from the Setup Test menu. From the main menu select Setup Test. The next screen will display all the test files that are stored on the instrument memory.

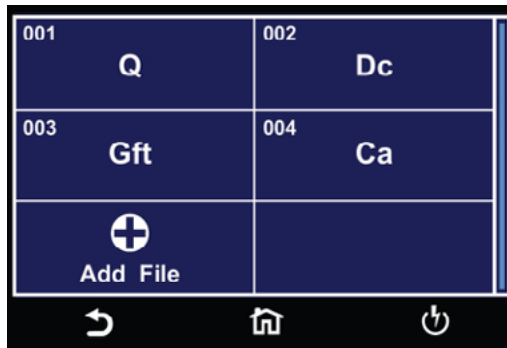

001	Q	002	Dc
003	Gft	004	Ca
		+	
		Add File	

To edit test files touch and hold the screen on a test file name and the screen should change to the following:



Save	Save As	Rename	Delete
001	Q	002	Dc
003	Gft	004	Ca

Select the test file and choose the operation you wish to perform from the following:

<b>Save</b>	Make changes to an existing test file and save the changes
<b>Save As</b>	Edit an existing test file and save the test file with a different name
<b>Rename</b>	Rename an existing test file
<b>Delete</b>	Delete an existing test file

If you choose to delete an existing test file a confirmation screen will appear as follows:

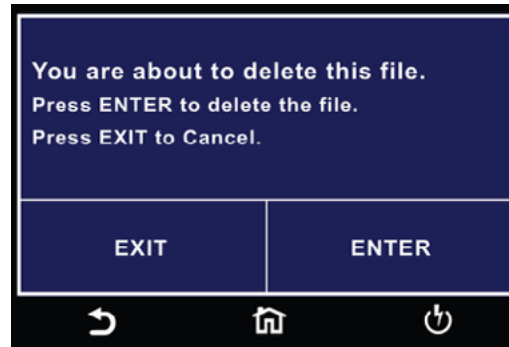

Select Exit to cancel deleting the test file or Enter to confirm the action.

### 3. Perform Tests

From the main menu select the Perform Test icon and the Perform Test screen will appear.

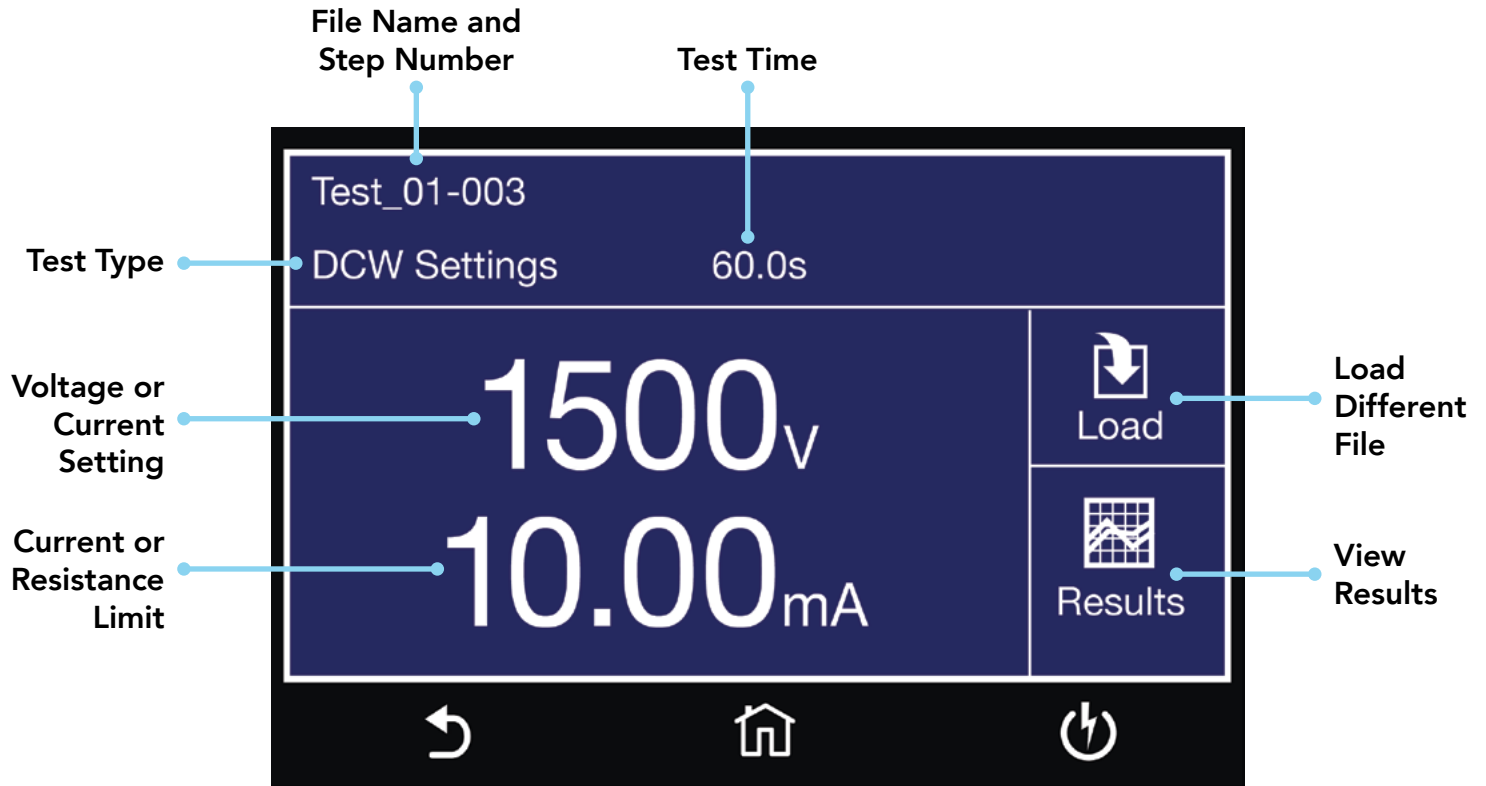

Perform Tests Screen

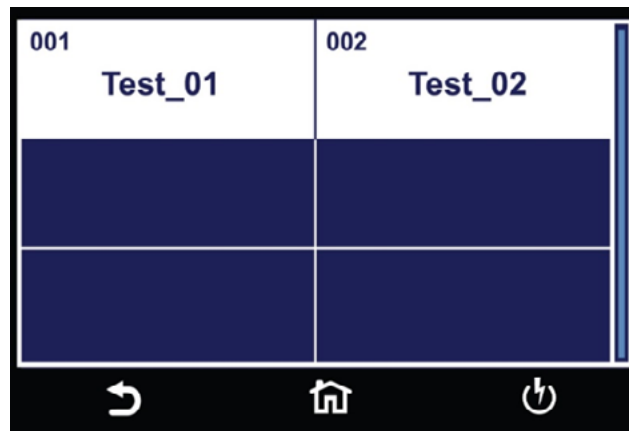

Load Test screen, if there are multiple test files saved in the instrument select the Load icon and all the test files will be displayed. You can select the test file and the first test step in the selected test file will be displayed.

## Instrument Connections

You may connect the test leads and the adaptor box to the receptacles located on the front or back of Hypot. These receptacles are wired in parallel and you can use either depending upon the application.

### Test Lead Connections

- 1 Connect the clip end of the return lead (P/N 2100A-13) to the exposed or dead metal on the chassis on the DUT. Always connect the ground return clip first and double check that it has a solid connection to the DUT.
- 2 Connect the black ground return lead (P/N 2100A-13) to the Return terminal located on the front panel of the instrument.
- 3 Connect the white high voltage lead (P/N 4040A-08) to the High Voltage terminal.
- 4 Connect the red clip end of the high voltage lead to the current carrying conductors of the DUT's circuitry.

### Exposed Metal Chassis Setup

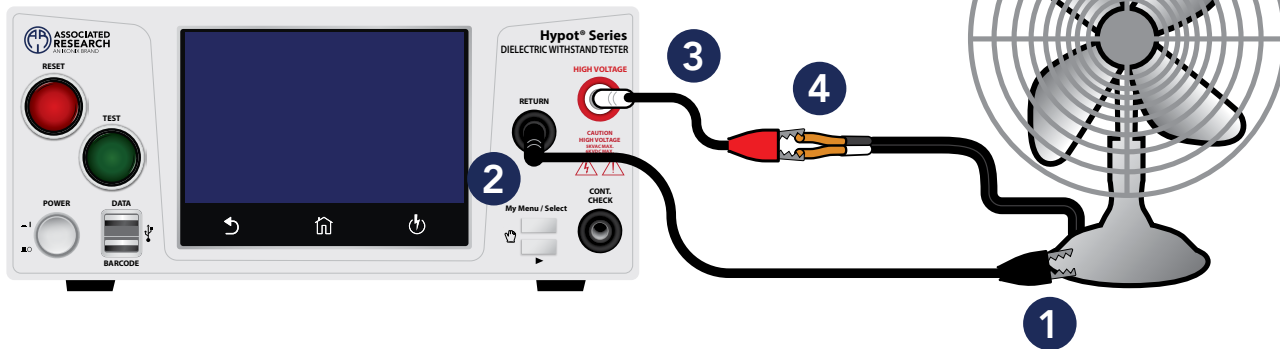

### Non Exposed Metal Chassis Setup

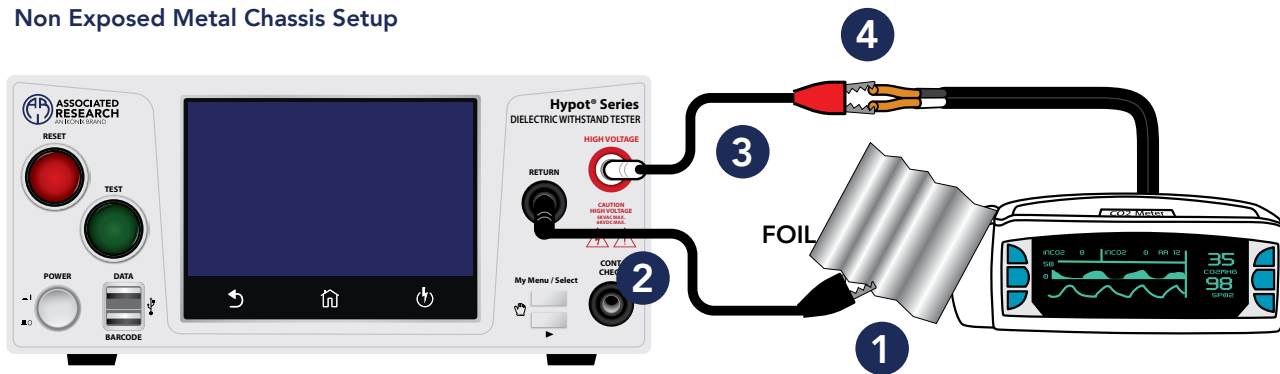

If there is no ground circuit present on the DUT, you can use test leads to connect the Hypot® to the DUT.

Did you know? If necessary, a 10 x 20 cm piece of foil can be attached to the enclosure to simulate a full hand contact to the DUT. This foil acts as the return point. The return and sense (-) terminal are attached to the foil. Always check to make sure you made a good connection between the DUT and the return clip.

## Adapter Box Connections

- 1 Connect the black ground return lead (P/N 2100A-13) to the front panel Return terminal and connect the other end of the lead to the dead metal on the chassis of the DUT. Check to ensure a solid connection is made between the DUT and the return clip.
- 2 Plug the black lead from the adapter box (P/N 365440) into the CONT. CHECK terminal located on the front panel.
- 3 Plug the white lead from the adapter box into the High Voltage terminal located on the front panel.
- 4 Plug the line cord of the DUT into the adapter box receptacle.

 WARNING: DO NOT TOUCH THE DEVICE UNDER TEST ONCE YOU START THE TEST.

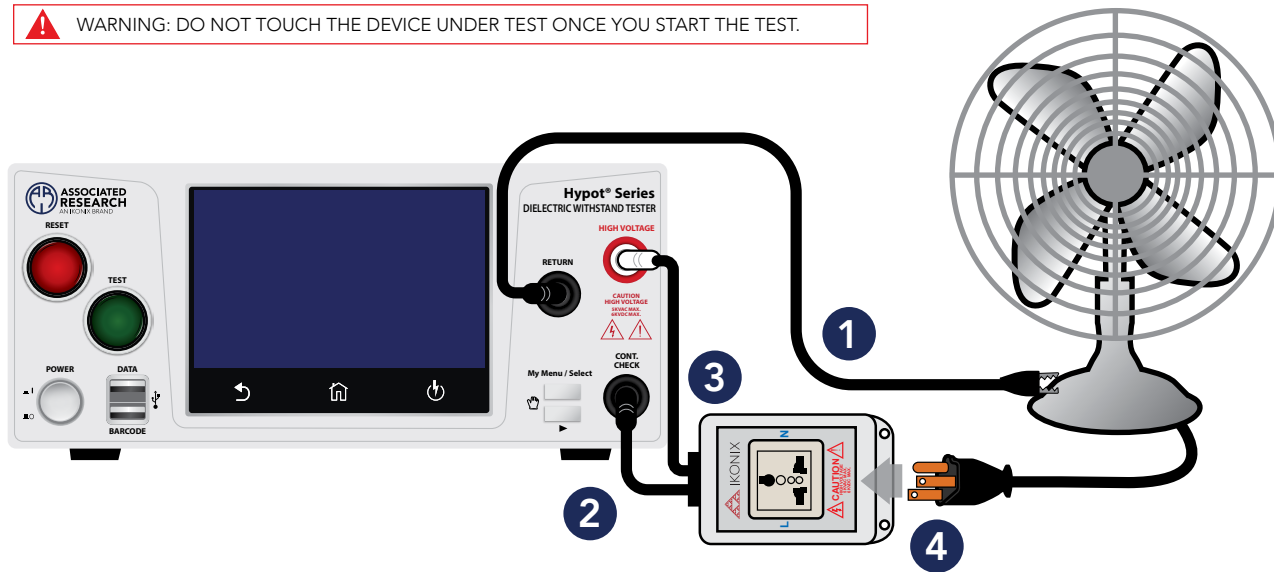

## Manual Voltage Adjustment

When Hypot is performing a test, "+" and "-" icons will appear on touch screen. These icons may be used to adjust the output voltage while performing a test.

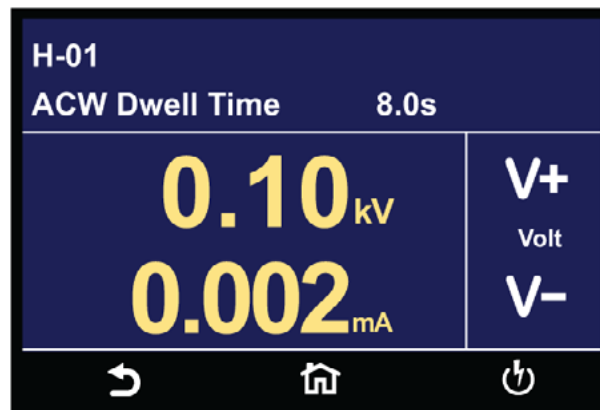

Pressing the "+" icon will increase the output voltage and pressing the "-" icon will decrease the output voltage. Manual voltage adjustment temporarily overrides the voltage setting and only remains in effect until the test is terminated by Pass, Fail, or Abort conditions. When Security feature is ON, manual voltage adjustment is disabled for users with limited access. You will not see the "+" and "-" soft key selections in this case.



## Failure Modes

Failure Message	Test Type	Description
<b>Abort</b>	All	This message appears on the display if you abort the test in process with the RESET button or remote Reset control.
<b>HI-Limit</b>	ACW, DCW, IR	This message appears on the display if the DUT measurement exceeds the HI-Limit setting of any parameter.
<b>LO-Limit</b>	ACW, DCW, IR	This message appears on the display if the DUT measurement drops below the LO-Limit.
<b>CONT. HI-Limit</b>	ACW, DCW	This message appears on the display if the DUT fails the basic continuity check performed during an AC/DC Withstand test (if Continuity is selected "ON").
<b>Arc-Fail</b>	ACW, DCW	This message appears on the display if the DUT arcing current exceeds the Arc Sense limit and Arc function is active (Arc Sense = 1..9) of the AC/DC Withstand test.
<b>Short</b>	ACW, DCW, IR	This message appears on the display if the DUT current is well beyond the metering range of the test.
<b>Charge-LO</b>	DCW, IR	This message appears on the display if the leakage current during Ramp-up falls below the Charge -LO setting.
<b>Breakdown</b>	ACW, DCW	This message appears on the display if the DUT current is well beyond the metering range of the test and the arcing condition beyond the arc sense limit.
<b>GND-FLT</b>	ACW, DCW	This message appears on the display if the GFI threshold is exceeded during the test.
<b>Interlock Open</b>	All	This message appears on the display if the Remote Interlock feature is activated before or during a test. The Remote Interlock feature utilizes a set of closed contacts which will disable the instrument's output if they are opened before or during a test. You can also refer to the Remote Interlock as a remote system lockout, utilizing "fail when open" logic. You can disable the Remote Interlock feature by plugging the "Interlock Disable Key" provided into the Signal Input connector
<b>Ramp-Hi</b>	DCW	This message appears on the display when the Ramp-Hi limit is exceeded during the test.
<b>OTP-Fail</b>		This message appears on the display if the Power Amplifier has overheated. This is an abnormal condition; please call to the factory for assistance.

## Error Messages

**Output Error:** This message appears on the display, if the instruments output reading does not match the setting. You will only see this message if you press the EXIT key at the Output Error screen. If the instrument has an output problem when the TEST button is pressed, the Output Error screen will appear as in image below. Bus will return "OUT-ERROR" if instrument is queried in this state.



The RESET button is not active in this situation. Only the EXIT key will allow you to return to the Perform Test screen.

**Voltage at Return:** The Hypot contains a protective circuit on the Return. This circuit has the capability to protect the instrument from getting damaged as result of line voltage coming back into the Return circuit. If the instrument detects any line voltage on the Return circuit then the following screen will appear:

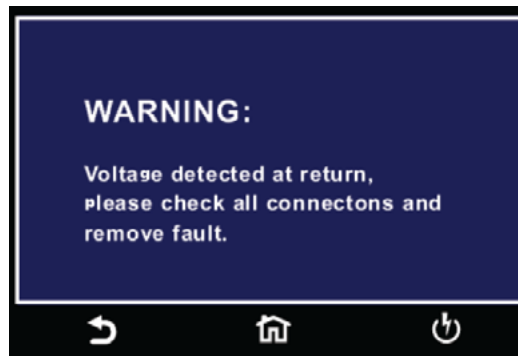

You can then check for any inappropriate connections.

## Meters

The Perform Test screen of the Hypot has several different meters depending on the type of test you are performing. You can arrange these meters as desired. You can also tie these meters to the user security setup. The drag and drop feature of the instrument allows you to set large and small meters. For example the following screen shot shows the Perform Test screen of the DCW test:

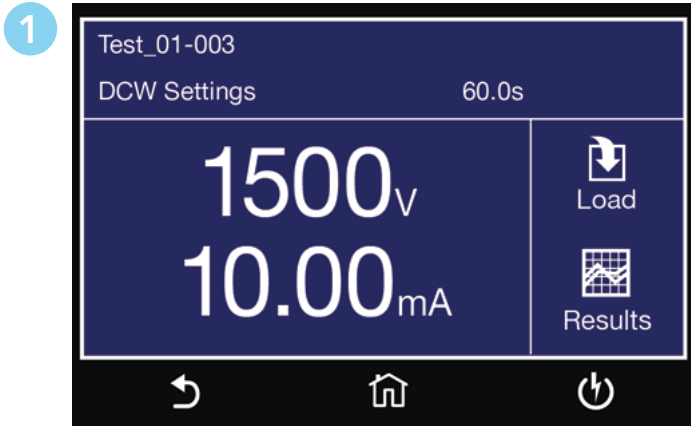

In the image above, the two large meters display the DCW test voltage and the Dwell Time.

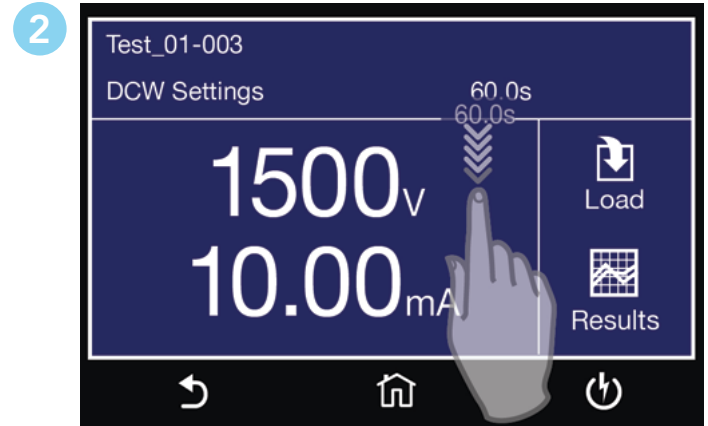

Touch and hold the display on any of the meters and drag it on to the location of a different meter and the two meters will be swapped.

## Viewing Test Results

After a test has completed the Results icon will be available on the screen. For example:

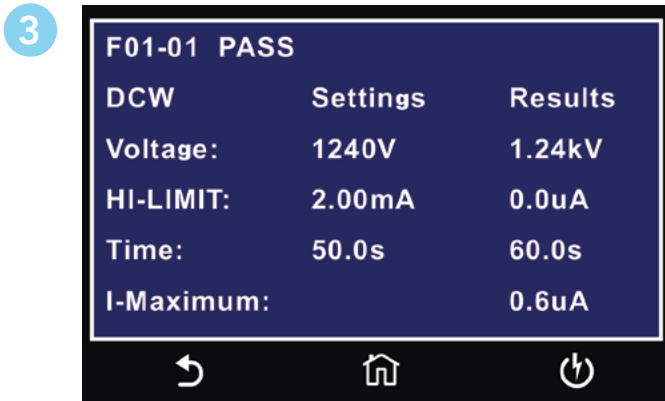
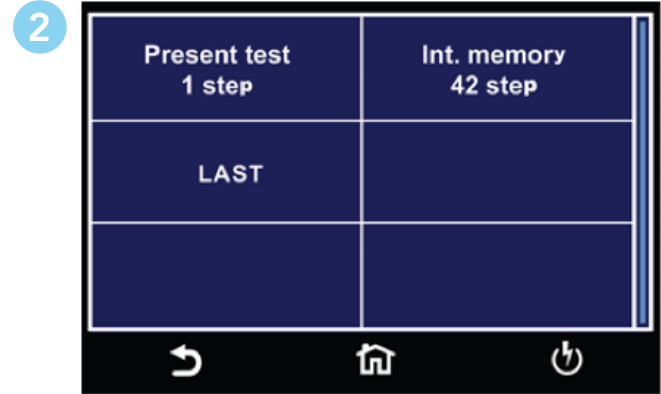
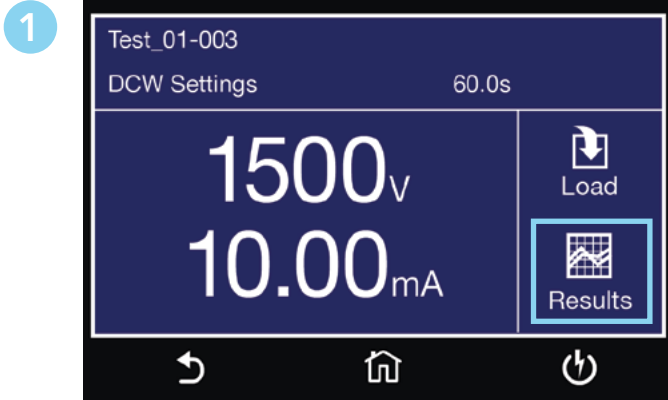

Select Present Test to view test results from the current test sequence that was executed. Select any test step to view more details regarding the test.

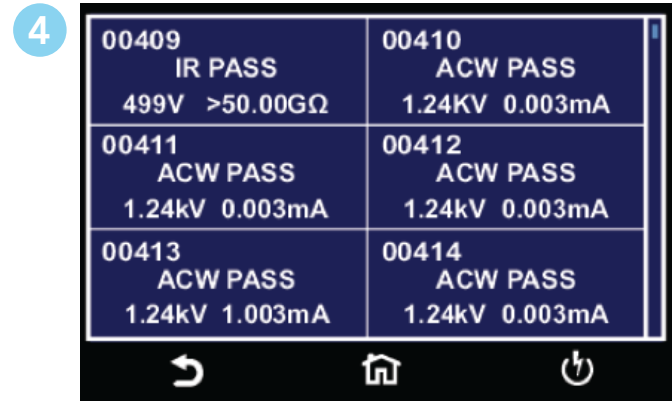

Select Int. Memory to view all the test results stored on the internal memory of the instrument. Scroll down to view all the test results.

## Transfer Test Results

Touch and hold any test step result on the previous screen and the transfer menu will appear. (screen #3 below)



From Perform Test screen tap Results icon and select int. memory.

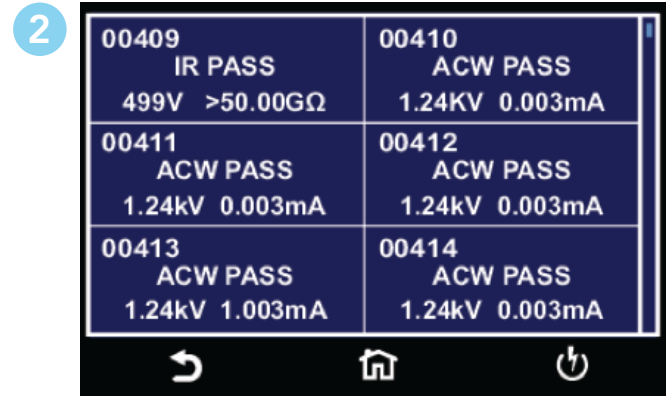

Touch and hold any test step result and transfer menu will appear.

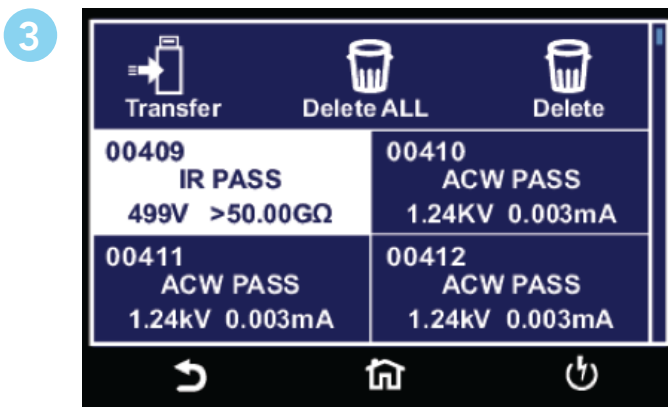

Press transfer to begin exporting internal memory results.



Enter name for Results File.

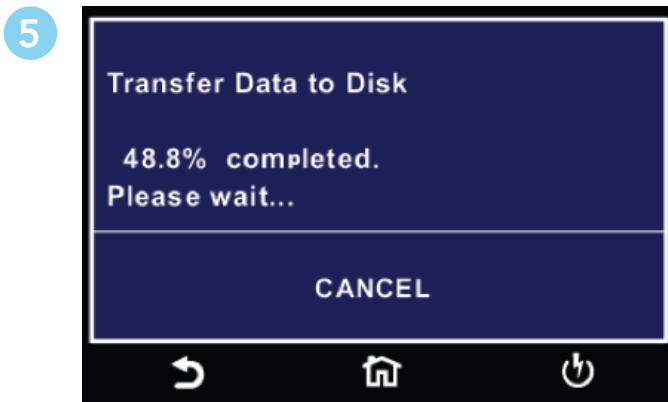

Transfer results progress.

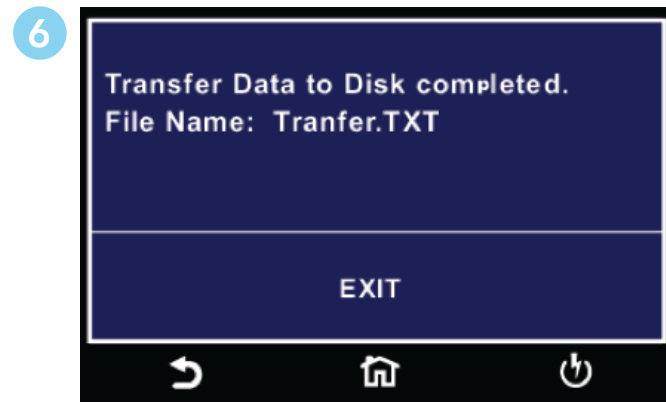

Transfer results complete.

From this screen you can transfer All results to a USB disk, delete All results or delete a single result. Selecting Delete ALL will delete all the test results from the internal memory. Selecting delete will delete a selected step.

To transfer results to a USB disk select the Transfer icon and a new pop up screen will appear where a file name must be entered for the results file. The results will be saved on the USB disk with this file name:

Once you assign and save a file name the following screen will appear showing the transfer status:

Once the results file transfer is complete a message will appear on the screen confirming the successful transfer along with the results file name that was previously assigned.

# 4. Security

Instrument security and user setup screen. The first option under Security allows you to set Security to ON or OFF.

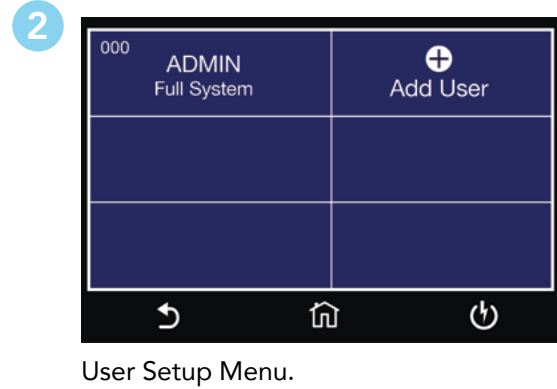
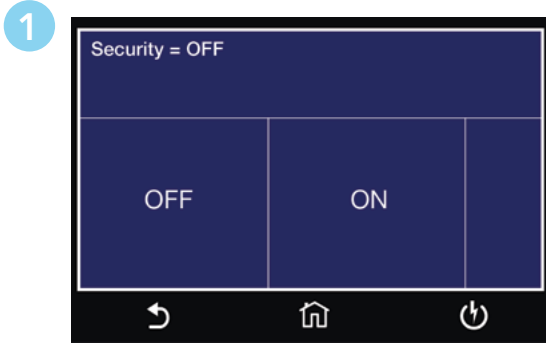
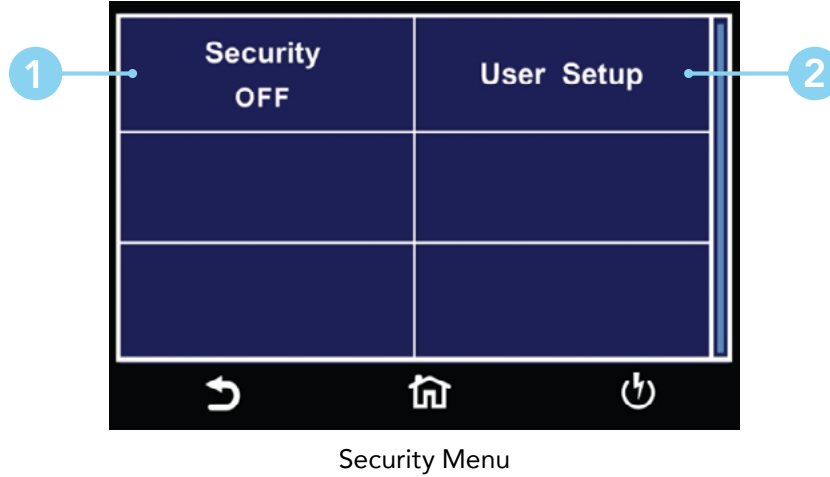

## User Setup

The next option under security is User Setup where multiple users can be added and assigned different privileges.



Enter New User ID.

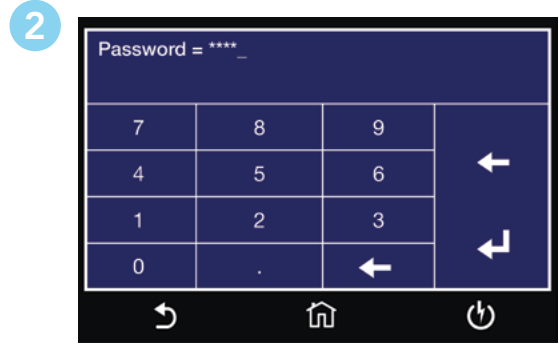

Enter Password.

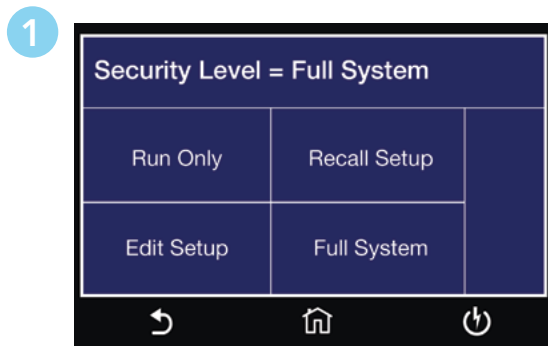

Select Security Level.

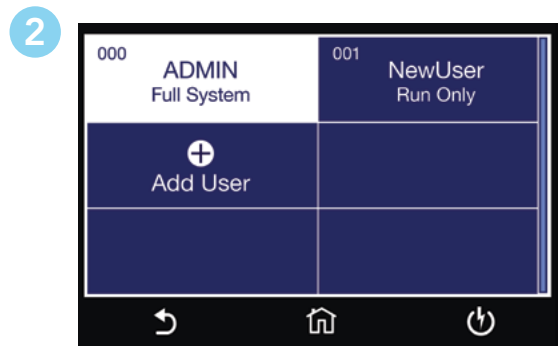

User Setup Menu updated.

Security Level	Description
<b>Full System</b>	In this mode you have full access level to all instrument setup parameters as well as system configuration and security levels. Access at this level should be restricted to System Administrators.
<b>Edit Setup</b>	In this mode you can load files and edit test parameters.
<b>Recall Setup</b>	This mode allows you to load previously configured test files but it does not allow any editing of the parameters. In this mode you are restricted from access to the "Setup Test Parameters" screen.
<b>Run Only</b>	<p>This is the most restricted mode of user access. You can only initiate a test, reset a failure or abort a test from the Perform Tests screen.</p> <p><b>NOTE:</b> whenever your security level is Run Only, "Single Step" and "Fail Stop" soft keys will be disabled at the Perform Test screen.</p> <p><b>NOTE:</b> whenever your security level is Run Only, you may only start at test step 1.</p>

### Security – Forgotten Password

If you have forgotten your password you may access all security functions by typing in the number "8000" into the password field. The old password cannot be recovered and a new password needs to be entered.

## 5. FailCHEK

FAILCHEK is the process by which an instrument's failure detectors are proven to be functioning properly. Safety agencies such as CSA, UL and TÜV require checking the failure detection circuitry of the electrical safety instrument. To perform FAILCHEK touch the test icon and follow instructions on the instrument screen.

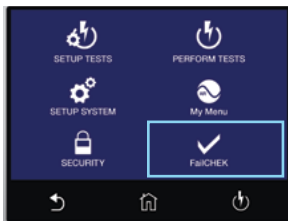

Main Menu

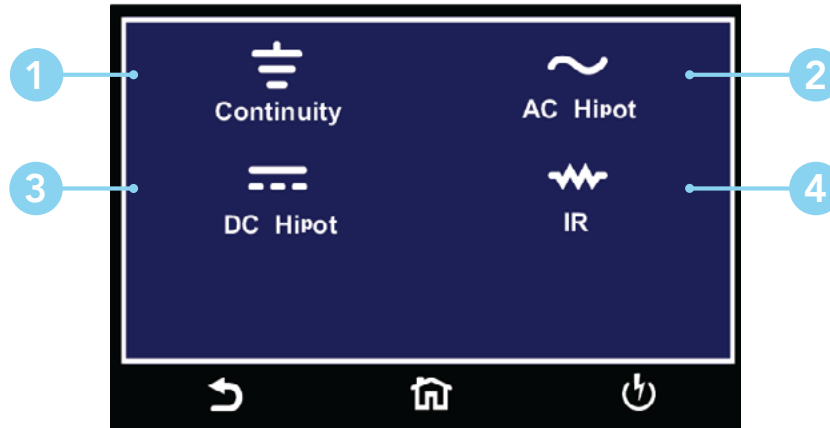

FailCHEK Menu

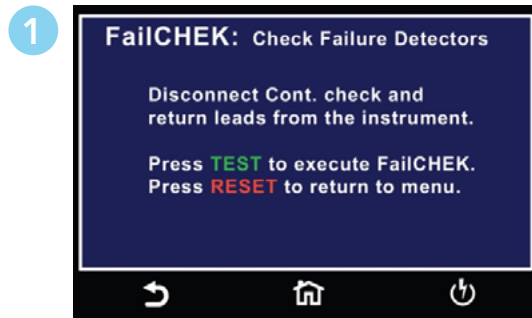

Continuity FailCHEK screen

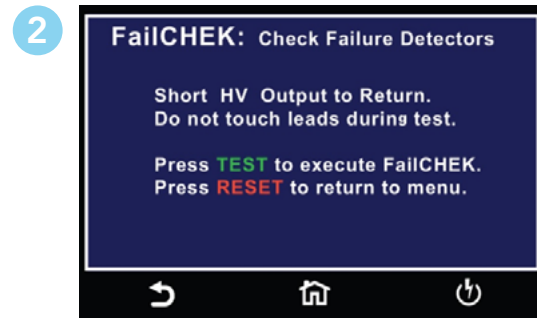

AC Hipot FailCHEK screen

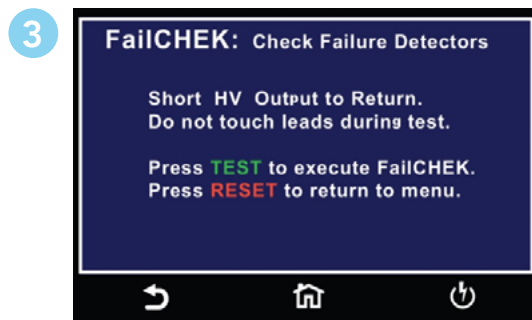

DC Hipot FailCHEK screen

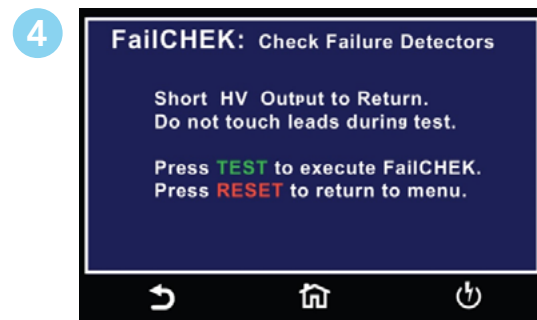

IR FailCHEK screen



## FailCHEK Continuity

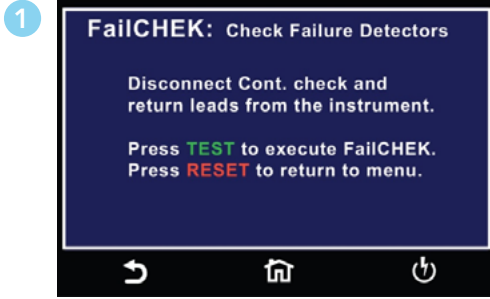

To perform Continuity FailCHEK follow on-screen instructions.

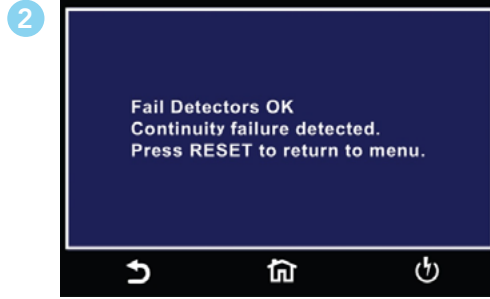

Continuity Fail Detectors OK screen.



Continuity Fail Detectors ERROR screen.

## FailCHEK AC Hipot

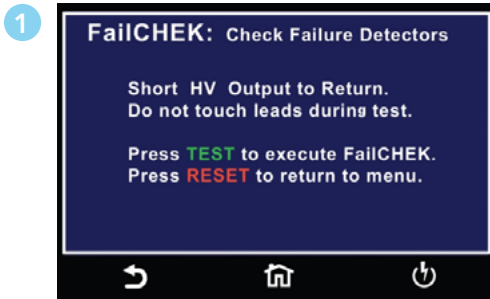

To perform AC Hipot FailCHEK follow on screen instructions.

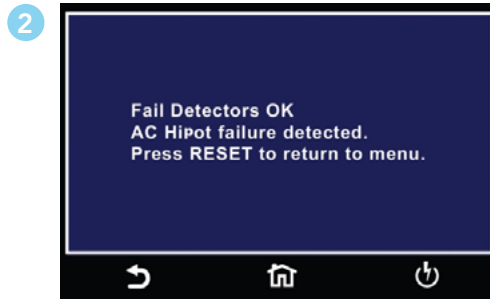

AC Hipot Fail Detectors OK screen.

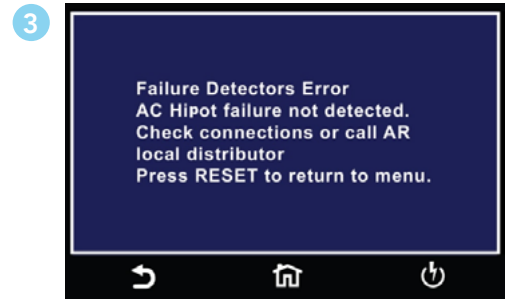

AC Hipot Fail Detectors ERROR screen.

## FailCHEK DC Hipot



To perform DC Hipot FailCHEK follow on screen instructions and press Green TEST Button or Red RESET to return to previous menu.



DC Hipot Fail Detectors OK screen.

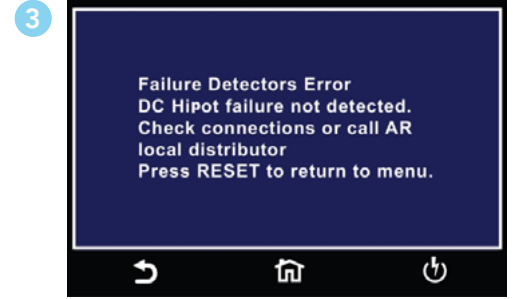

DC Hipot Fail Detectors ERROR screen.

## FailCHEK Insulation Resistance

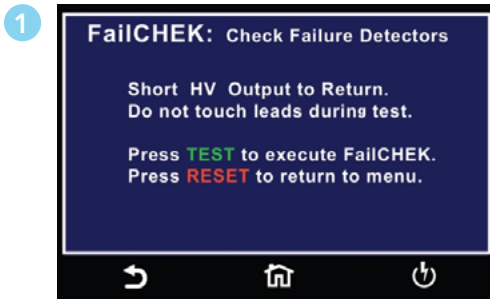

To perform IR Hipot FailCHEK follow on screen instructions and press Green TEST Button or Red RESET to return to previous menu.



IR Fail Detectors OK screen.

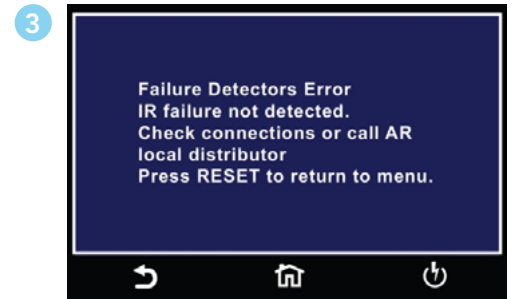

IR Fail Detectors ERROR screen.

## 6. MyMenu

The MyMenu function allows the user to configure a custom menu. User can store the desired test files under MyMenu and access the files by a single touch.



Main Menu



Select Add New to add test file to MyMenu



Select file to be added to MyMenu.

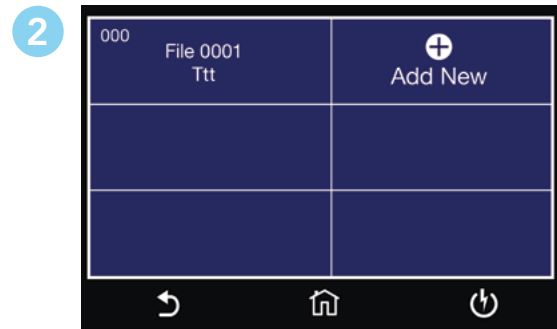

MyMenu Screen.

# Using Remote I/O and PLC Control

Two 9-pin "D" type connectors mounted on the rear panel provide REMOTE-INPUT-OUTPUT control and information.

- These connectors mate with a standard 9 pin D-sub-miniature connector provided by the user.
- The output mates to a male (plug) connector while the input mates to a female (receptacle) connector.
- For best performance, you should use a shielded cable. To avoid ground loops you should not ground the shield at both ends of the cable.

## Suggested AMP part numbers for interconnecting to the Remote I/O

Part Number	Description
205204-4	Plug shell with ground indents
205203-3	Receptacle shell
745254-7	Crimp snap-in pin contact (for plug)
745253-7	Crimp snap-in socket contact (for receptacle)
745171-1	Shielded cable clamp (for either plug or receptacle)
747784-3	Jackscrew set (2)

## Remote I/O Pinouts

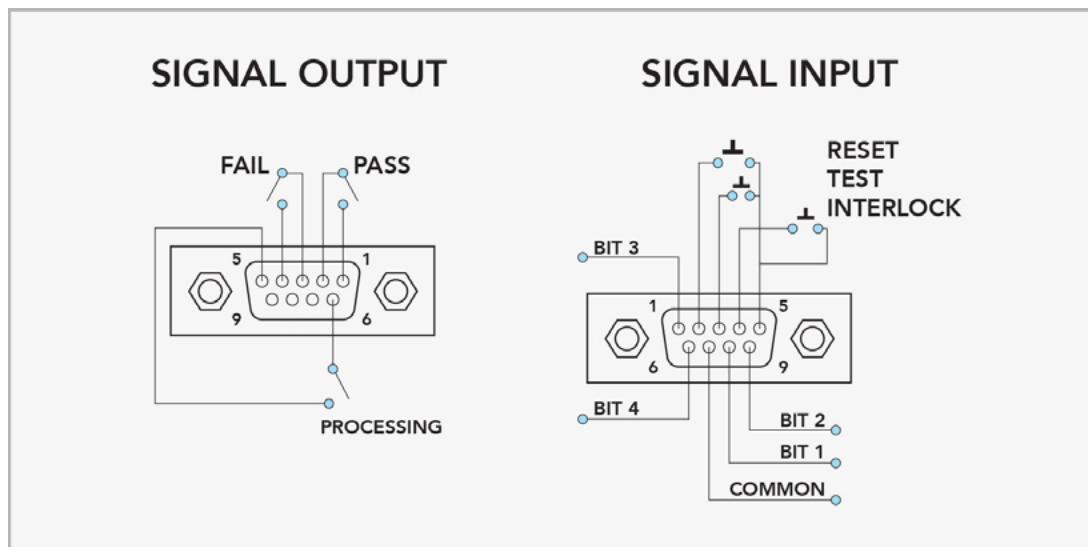

## Signals on Remote I/O

### REMOTE INPUT/OUTPUT

#### Remote Output

The rear panel connector provides three output signals to remotely monitor PASS, FAIL, and PROCESSING conditions. The monitoring signals are provided by three normally open internal relays that toggle ON and OFF to indicate the condition of the instrument. These are normally open free contacts and will not provide any voltage or current.

Output Signal	Pins	Description
PASS	1 and 2	The relay contact closes after detecting that the device under test passed all tests. The connection is opened when the next test is initiated or the reset function is activated.
FAIL	3 and 4	The relay contact closes after detecting that the device under test failed any test. The connection is opened when the next test is initiated or the reset function activated.
PROCESSING	5 and 6	The relay contact closes while the tester is performing a test. The connection is opened at the end of the test.

*These are normally open free contacts and will not provide any voltage or current. The ratings of the contacts are 1 AAC / 125 VAC (0.5 ADC / 30 VDC). When a terminal becomes active, the relay closes thereby allowing the external voltage to operate an external device.*

#### Remote Input

The Hypot remote connector enables remote operation of the TEST, RESET, and REMOTE INTERLOCK functions, and allows you to select one of 3 pre-programmed test files. (7 memories available with added option)

Output Signal	Pins	Description
TEST	3 and 5	A normally open momentary switch can be wired across pins 3 and 5 to allow remote operation of the TEST function. A minimum pulse width or contact closure of 20mS is required to guarantee a test start.
RESET	2 and 5	A normally open momentary switch can be wired across pins 2 and 5 to allow remote operation of the RESET function. For safety, the front panel RESET button remains active even when a remote reset switch is connected so that high voltage can be shut down from either location. A minimum pulse width or contact closure of 50mS is required to guarantee that a running test will abort.
INTERLOCK	4 and 5	Remote Interlock utilizes a set of closed contacts to enable the tester's output. The output of the tester will be disabled under the following conditions: <ul style="list-style-type: none"> <li>• If the Interlock contacts are open and the TEST button is pushed</li> <li>• If the interlock contacts are opened during a test (test will automatically abort)</li> </ul>

A pop-up message will be displayed on the screen:



The tester can still be used without the external interlock device as long as the Interlock Connector (P/N # 38075 provided with unit) is plugged into the Remote Interface, Signal Input port. If there is nothing connected to the Remote Interface, Signal Input port to provide a connection to the interlock, the tester will not perform tests.

*When the PLC Remote mode is ON, the tester will respond to simple switch or relay contacts closures. When the PLC Remote function is ON the TEST button on the front panel will be disabled.*

## Remote Signal Inputs and Memory Access

- The Remote File Select function gives you the capability to quickly select and initiate a test remotely.
- You can access first three (3) pre-programmed test files by connecting pins 1, 6, 8 and 9 to the common pin 7, in different combinations. (7 memories available with added option)
- The memory select bits should be set simultaneously and remain set for a minimum of 20ms to guarantee that the correct memory will be selected.
- The memory select bits may be set in sequential manner, provided that the time delay between each bit is less than 4ms.
- When the desired bit pattern has been established it should remain set for a minimum of 20ms to guarantee that the correct memory will be selected.
- It may be necessary to "OR" the momentary switches (relay contacts) to prevent incorrect program selection due to timing errors.

### DID YOU KNOW...

The Remote Signal Input connector may be used with various accessories, including light curtains, foot switches, and safety probes. Contact Associated Research for more information.

REMOTE FILE SELECT TRUTH TABLE

BIT 3	BIT 2	BIT 1	FILE #
0	0	1	01
0	1	0	02
0	1	1	03
1= Momentary Contact closure between BIT and COMMON			
0= No Contact closure between BIT and COMMON			

### WARNING

Activating memory program functions through the remote connector, selects the program and starts the test which is preprogrammed into that memory

Activation des fonctions de mémoire programme via le connecteur remote , sélectionne le programme et lance le test qui est préprogrammé dans cette mémoire.

### CAUTION

Do not connect voltage or current to the signal inputs, this could result in damage to the control circuitry.

Ne pas connecter tension ou de courant aux entrées de signal, cela pourrait provoquer des dommages au circuit de contrôle.

# Appendix A - Installation and Test Operator Information

## Installation

### 1. Unpacking and Inspection

Your instrument ships in a custom foam insulated container. If the shipping carton is damaged, inspect the contents for visible damage such as dents, scratches or a broken display. If the instrument is damaged, notify the carrier and Associated Research's customer care department. Please save the shipping carton and packing material for the carrier's inspection. Our customer care department will assist you in the repair or replacement of your instrument. Please do not return your product without first notifying us and receiving an RMA (return material authorization) number. To receive an RMA number, please contact our customer care department at **1-800-858-TEST (8378)**.

### 2. Safe Lifting and Carrying Instructions

Proper methods of lifting and carrying can help to protect against injury. Follow the recommendations below to ensure that instruments are handled in a safe manner.

- Determine if the instrument can be lifted by one individual or requires additional support.
- Make sure that your balance is centered and your feet are properly spaced, shoulder width apart behind the instrument.
- Bend at the knees and make sure your back is straight.
- Grip the instrument with your fingers and palms and do not lift unless your back is straight.
- Lift up with your legs, not your back.
- Keep the instrument close to your body while carrying.
- Lower the instrument by bending your knees. Keep you back straight

### 3. Contents of the Carton

DESCRIPTION	AR PART NUMBER
<b>Hypot® Instrument</b>	<b>38XX</b>
High Voltage Cable	04040A-08
Return Cable	02100A-13 (Qty.2)
USB Cable AB-Type 1.8m	39066
Fuse	37880 38430 (Model 3880)
Line Cord*	33189 Standard
Adapter Box*	36544 Standard
Interlock Connector	38075
8GB USB Flash Drive	39571

\*The Line Cord listed is American. Other combinations of the Line Cord are available upon request.

## WARNING

Use only accessories that meet the manufacturer's specification.

Utiliser uniquement des accessoires conformes aux spécifications du fabricant.

## 4. Preparation for Use

### Power Requirements

This instrument requires a power source of either 115 volts AC  $\pm$  10%, 50/60 Hz single phase or 230 volts AC  $\pm$ 10%, 50/60 Hz single phase. See section for Rear Panel Controls for an image of the rear panel.

## CAUTION

Do not replace the power supply cord with an improperly rated cord. For North American: A UL listed and CSA labeled power cord must be used with the instrument in the United States and Canada. The power cord must include a NEMA5-15 style male plug, SVT or SJT cord sets, and be rated for at least 125VAC, 10A, number 16 gauge (or 125VAC, 15A, number 14 gauge) wire or larger, and the length of the cord does not exceed 2 m must be used. For European: A certified power supply cord not lighter than light PVC sheathed flexible cord according to IEC 60227, designation H03 VV-F or H03 VVH2-F (for equipment mass not exceeding 3 kg), or H05 VV-F or H05 VVH2-F2 (for equipment mass exceeding 3 kg), and be rated for at least 3G 0.75 mm<sup>2</sup> (for rated current up to 10 A) or 3G 1.0mm<sup>2</sup> (for rated current over 10 A up to 16 A) wire or larger, and the length of the cord does not exceed 2 m must be used.

Ne remplacez pas le cordon d'alimentation avec un cordon mal classé . Pour l'Amérique du Nord: Une UL et CSA marqué cordon d'alimentation doit être olariz avec l'instrument aux États-Unis et Canada . Le cordon d'alimentation doit comporter une fiche mâle NEMA5-15 de style , SVT ou ensembles SJT de la moelle , et être classé pendant au moins 125VAC , 10<sup>a</sup> , numéro de calibre 16 ( ou 125VAC , 15<sup>a</sup> , numéro de calibre 14 ) fil ou plus, et la longueur de le cordon ne dépasse pas 2 m doit être utilisé . Pour européenne : Un cordon d 'alimentation certifié , pas plus léger que le PVC lumière câbles souples sous gaine selon la norme IEC 60227 , la désignation H03 VV- F ou H03 VVH2 – F ( pour la masse de l'équipement ne dépassant pas 3 kg ) , ou H05 VV- F ou H05 VVH2 – F2 (masse d' équipement de plus de 3 kg) , et être prévus pour au moins 3G 0,75 mm <sup>2</sup> ( pour courant nominal jusqu'à 10 A ) ou 3G 1.0mm<sup>2</sup> ( pour fil nominale ou plus actuelle plus de 10 A à 16 A ) , et la longueur du cordon ne doit pas excéder 2 m doit être utilisé.

## WARNING

The Hypot must be connected to a good ground. Be certain that the power wiring is properly polarized and that the proper low resistance bonding to ground is in place.

L'Hypot doit être relié à un bon sol. Assurez-vous que le câblage d'alimentation est correctement polarisé et que la bonne résistance à la terre est en place.

## 5. Power Cable

The instrument is shipped with a line cord containing a protective earth ground. When the line cord is connected to an appropriate AC power source the cable will connect the chassis to earth ground.

## WARNING

Only insert the main plug in a socket outlet with a protective ground (earth) contact. This protective ground must not be defeated by the use of an extension cord without a protective conductor.

La fiche principale ne doit être insérée dans une prise de courant avec une masse (terre ) avec système de protection . Cette terre de protection ne doit pas être vaincu par l'utilisation d' une rallonge sans conducteur de protection.

This instrument is shipped with a three-wire power cable. When this cable is connected to an appropriate AC power source, this cable connects the chassis to earth ground. The type of power cable shipped with each instrument depends on the country of destination.



## Operating Environment

This equipment is intended for indoor use only. The equipment has been evaluated according to Installation Category II and Pollution Degree 2 as specified in IEC 664.

Operate this instrument in environments with the following limits:

Temperature ..... 41° - 104° F (5° - 40°C)

Relative humidity ..... 0 – 80%

Altitude ..... 6560 feet (2,000 meters)

### WARNING

Do not block any ventilation openings to prevent over heating of the equipment. Keep the ventilation slits uncovered during operation. Failure to do so could cause the instrument to overheat and may damage internal components.

Ne pas bloquer les ouvertures de ventilation pour éviter la surchauffe de l'équipement. Gardez les fentes de ventilation découverts au cours de l'opération. Ne pas le faire pourrait entraîner l'instrument de surchauffer et endommager les composants internes.

## Storage and Shipment

Store or ship this instrument in environments with the following limits:

Temperature ..... -40° - 167° F (-40° - 75°C)

Altitude ..... 50,000 feet (15,240 meters)

Also protect this instrument against temperature extremes that may cause condensation within the instrument.

### CAUTION

Failure to operate this instrument within the specified conditions could result in damage.

L'incapacité à manipuler cet instrument dans les conditions spécifiées peuvent entraîner des dommages.

If the instrument is used in a manner not specified by the manufacturer, the protection provided by the instrument may be impaired.

### More Information

For more information on test operator and workstation safety please visit the Events and Training section of our website at [www.arisafety.com](http://www.arisafety.com).

## Test Operator and Safety Considerations

### 1. Qualifications

### WARNING

This instrument generates voltages and currents that can cause harmful or fatal electric shock and must only be operated by a skilled worker trained in its use. The operator should understand the electrical fundamentals of voltage, current, and resistance.

Cet instrument produit des tensions et des courants qui peuvent causer des chocs électriques dangereux ou mortel et ne doivent être exploitées par un travailleur qualifié formé à son olarize ve . L'opérateur doit comprendre les principes fondamentaux électriques de tension, courant et la résistance.

### WARNING

Do not touch the device under test, high voltage test lead, alligator clip, or clip insulator once the test has been started.

Ne touchez pas l'appareil sous test, le fil de test haute tension, le crocodile ou l'isolateur de clip une fois le test lancé.

## WARNING

Do not touch the front panel when testing or after a malfunction has occurred.

Ne olariz pas la face avant lors de l'essai ou après un dysfonctionnement s'est produit.

*The operator should understand the electrical fundamentals of voltage, current, and resistance.*

## 2. Safety Procedures

Operators should be thoroughly trained to follow these and all other applicable safety rules and procedures before they begin a test. Defeating any safety system should be treated as a serious offense and should result in severe penalties, such as removal from the Hipot testing job. Allowing unauthorized personnel in the area during a test should also be dealt with as a serious offense.

Refer to the following standards for more information:

- NFPA 70E
- OSHA 1910 subpart (S)
- EN50191

## 3. Dress

### WARNING

Operators should not wear jewelry that could accidentally complete a circuit.

Do not observe ESD protocols while performing electrical safety tests. Intentionally grounding the test operator could lead to a harmful or fatal electric shock.

Protocoles de l'EDD ne devraient pas être respectés lors de l'exécution des tests de sécurité électrique. Intentionnellement à la terre à l'opérateur de test pourrait conduire à un choc électrique dangereux ou mortel.

## 4. Medical Restrictions

Inform personnel with heart ailments or devices such as pacemakers that the voltages and currents generated by the instrument are very dangerous. If contacted, the instrument may cause heart-related problems. Please have the test operator consult a physician for recommendations.

## 5. Test Station

### Location

Select an area away from the main stream of activity which employees do not walk through in performing their normal duties. If this is not practical because of production line flow, then the area should be roped off and marked for HIGH VOLTAGE TESTING. No employees other than the test operators should be allowed inside. If benches are placed back-to-back, be especially careful about the use of the bench opposite the test station. Signs should be posted: "DANGER - HIGH VOLTAGE TEST IN PROGRESS - UNAUTHORIZED PERSONNEL KEEP AWAY."

### WARNING

The mains plug is used as the disconnecting device and shall remain readily operable. The socket-outlet shall be installed. Near the equipment and shall be easily accessible.

La fiche secteur est utilisée comme dispositif de déconnexion et doit rester facilement opérationnelle. La prise de courant doit être installée. Près de l'équipement et doit être facilement accessible.

## Work Station

Perform the tests on a non-conducting table or workbench, if possible.

There should not be any metal in the work area between the operator and the location where products being tested will be positioned.

Position the instrument so the operator does not have to reach over the product under test to activate or adjust the instrument. If the product or component being tested is small, it may be possible to construct guards or an enclosure, made of a non-conducting material such as clear acrylic, such that the item being tested is within the guards or enclosure during the test, and fit them with switches so that the instrument will not operate unless the guards are in place or the enclosure closed. The outlet which is used to provide power to the instrument should be easily accessible.

Keep the area clean and uncluttered. All test equipment and test leads not absolutely necessary for the test should be removed from the test bench and put away. It should be clear to both the operator and to any observers which product is being tested, and which ones are waiting to be tested or have already been tested. If the instrument is used in a matter not specified by Associated Research the protection provided by the instrument may be impaired.

Do not perform Hipot tests in a combustible atmosphere or in any area where combustible materials are present.

### KEY SAFETY POINTS TO REMEMBER

- Keep unqualified and unauthorized personnel away from the test area.
- Arrange the test station in a safe and orderly manner.
- Never touch the product or connections during a test.
- In case of any problem, turn off the high voltage first.
- Properly discharge any item tested with DC before touching connections.

# Appendix B – Instrument Specifications

## Models 3805, 3865, 3870 and 3880 Functional Specifications

Unless otherwise stated, accuracy's are relative to a laboratory standard measurement.

INPUT			
Voltage	100 - 120VAC / 200 - 240VAC±10% Auto Range		
Frequency	50/60Hz ± 5%		
Fuse	3805, 3865 and 3870: 3.15A / 250VAC Fast-Blow 3800: 15A / 250VAC Fast- Blow		
AC WITHSTAND VOLTAGE (All Hypot Models)			
	Range	Resolution	Accuracy
Output Voltage, AC	0 - 5000	1	± (1.5% of setting + 5V)
Output Frequency	50Hz/60Hz ± 0.1% , User Selection,		
Output Waveform	Sine Wave , Crest Factor = 1.3 - 1.5		
Short Circuit Protection	3805, 3855, 3865 and 3870: minimum current 22mA RMS at short circuit, Response time < 2ms 3880: Output short Circuit current >200mA, Response time < 2ms		
Output Regulation	± (1% of output + 5V), From no load to full load and Low Line to High Line (combined regulation)		
SETTINGS			
Auto Range			
HI-Limit current, mA	0.00 – 20.00 0.00 – 99.99 (Model 3880)	0.01 0.01	± (2% of setting + 2 counts) ± (2% of setting + 6 counts)
LO-Limit current, mA	0.000 - 9.999 0.000 – 9.999 (Model 3880)	0.001 0.001	± (2% of setting + 2 counts) ± (2% of setting + 6 counts)
Ramp-Up Timer, second	0.1 - 999.9	0.1	± (0.1% + 0.05 sec)
Ramp-Down Timer, second	0.0 - 999.9		
Dwell Timer, second	0, 0.2 - 999.9 (0=continuous)		
Ground Continuity Current	Current: DC 0.1 A ± 0.01A, fixed		
Ground Continuity HI-Limit LO-Limit Offset	Max. Ground Resistance: 1.0 Ω ± 0.1Ω 0.00 - 1.50 0.00 - 1.50 0.00 - 0.50	0.01	± (3% of setting + .02Ω)
Arc Detection	1 - 9 ranges (9 = highest sensitivity)		

## DC WITHSTAND VOLTAGE (3865 and 3870 Only)

Output Voltage, DC	0 - 6000	1	± (1.5% of setting + 5V)
DC Output Ripple	<5 % ( 6KV / 7500 μA at Resistive Load)		
Short Circuit Protection	Minimum current 8250 μA AVG at short circuit, Response time < 2ms		
<b>SETTINGS</b>			
<b>Auto Range</b>			
HI-Limit, current, μA	0 – 7500	1	± (2% of setting + 2 counts)
LO-Limit, current, μA	0.0 – 999.9	0.1	
Ramp-Up Timer, second	0.1 - 999.9	0.1	± (0.1% + 0.05 sec)
Ramp-Down Timer, second	0, 1.0-999.9 (0 = OFF)		
Dwell Timer, second	0, 0.4 - 999.9, (0=continuous)		
Ramp-HI, current, μA	0.0 – 999.9	0.1	± (2% of setting + 2 counts)
	1000 – 7500	1	
Charge-LO, current	0.0 - 350.0 μA DC or Auto Set		
Discharge Time	≤ 50 ms for no load, < 100 ms for capacitor load (all capacitance values in MAX load spec below)		
Maximum Capacitive Load DC Mode	1μF < 1KV    0.08μF < 4KV		
	0.75μF < 2KV    0.04μF < 5KV		
	0.5μF < 3KV    0.015μF < 6KV		
Ground Continuity Current	Current: DC 0.1 A ± 0.01A, fixed		
Ground Continuity HI-Limit LO-Limit Offset	Max. Ground Resistance: 1.0Ω ± 0.1Ω		± (3% of setting + .02Ω)
	0.00 - 1.50		
	0.00 - 0.50		
Arc Detection	1 - 9 ranges (9 = Highest sensitivity)		

Continued on next page →

## INSULATION RESISTANCE (Model 3870)

Output Voltage, DC	30 - 1000	1	± ( 1.5% of setting + 5V)
<b>SETTINGS</b>			
HI and LO-Limit, resistance, MΩ	0, 1.00 - 99.99 (HI - Limit: 0 = OFF)	0.01	30-499V 1.00 -999.9, ± (8% of setting + 2 counts)
	100.0 - 999.9	0.1	500-1000V 1.00 – 999.9, ± (2% of setting + 2 counts)
	1000-50000	1	1000 - 9999, ± (5% of setting + 2 counts)
Ramp-Up Timer, second	0.1 – 999.9	0.1	± (0.1% + 0.05 sec)
Ramp-Down Timer, second	0.0, 1.0-999.9 (0 = OFF)		
Dwell Timer, second	0, 0.5 - 999.9 or 0 (0=continuous)		
Delay Timer, second	0.5 - 999.9 (0 = OFF)		
Charge-LO, current, μA	0.5 - 3.50 or Auto Set		

## MEASUREMENT

	Range	Resolution	Accuracy
Voltage, KV(AC/DC)	0.00 - 6.00	0.01	± ( 1.5% of reading) ≥ 500V ± ( 1.5% of reading +1 count) ≤ 500V
Voltage, VDC (IR only)	30 - 1000	0.01	± (1.5% of reading + 5V)
<b>Accuracy for AUTO range</b>			
AC Current, mA	0.000 - 4.000 RMS	0.001	± (2% of reading + 2 counts)
	3.50 - 20.00 RMS	0.01	
	3.50 - 99.99 RMS (3880 only)	0.01	± (2% of reading + 6 counts)
DC Current, μA	0.0 - 400.0 DC	0.1	± (2% of reading + 2 counts)
DC Current, mA	0.350 - 4.000 DC	0.001	
	3.50 - 7.50 DC	0.01	

Continued on next page →

<b>Resistance, MΩ (IR)</b>	30 - 99V	100 - 499V	500 - 1000V		30 - 499V
	1.000 - 1.999	1.000 - 1.999	1.000 - 9.999	0.001	1.00 - 999.9, ± (8% of reading + 2 counts)
	2.00-19.99	2.00 - 19.99	10.00 - 99.99	0.01	500 - 1000V 1.00 - 999.9, ± (2% of reading + 2 counts)
	20.0 - 199.9	20.00 - 199.9	100.0 - 999.9	0.1	1000 - 9999, ± (5% of reading + 2 counts)
	200 - 10000	200 - 20000	1000 - 50000	1	10000 - 50000, ± (15% of reading + 2 counts)

## GENERAL SPECIFICATIONS

<b>Safety Agency Listing</b>	CE, cTUVus, RoHS2
<b>PLC Remote Control</b>	Input: Test, Reset, Interlock, Recall File 1 through 3(Standard), Recall File 1 through 7(Option). Hardware Interlock- Direct control sine wave and amplifier relay off when Interlock signal is disabled. Output:- Pass, Fail, Test-in-Process (Output relay contact ratings is 1AAC/125VAC, 0.5ADC/30VDC)
<b>Memory</b>	50 steps 1500 test results
<b>Color LCD</b>	4.3" Color Display (Touch Panel)
<b>GFI</b>	Built-in Smart GFI circuit, GFI trip current 450 μA. HV shut down speed: <1mS
<b>Multinational language</b>	User interface available in English, Traditional Chinese, Simplified Chinese, Turkish, Portuguese, Spanish, German, French and Japanese
<b>Interface</b>	Standard: USB
<b>Security (Standard Password Protection)</b>	Programmable User ID and Password capability to avoid unauthorized access to test set-up program.
<b>Alarm Volume Setting</b>	Range: 0 - 9 ; 0 = OFF, 1 is softest volume, 9 is loudest volume
<b>Calibration</b>	Software and adjustments are made through the front panel. Automatic Calibration alert function to signal operator when the next calibration is due.
<b>Environment</b>	Temperature: 0 - 40°C, Humidity: 20 - 80% Not rack mountable with HYAMP Series 31XX
<b>Dimension</b>	Tilt up front feet Dimensions (W x H x D) 8.46 x 3.47 x 11.81 in (215 x 88.1 x 300 mm) 16.93 x 5.20 x 11.81 in (430 x 132 x 300 mm) – Model 3880
<b>Weight</b>	3880 = 50.71lb (23Kg) 3805, 3855, 3865, 3870 = 12lb (5.6Kg)

### Why use the term "Counts"?

Associated Research publishes some specifications using COUNTS which allows us to provide a better indication of the instrument's capabilities across measurement ranges. A COUNT refers to the lowest resolution of the display for a given measurement range. For example, if the resolution for voltage is 1V then 2 counts = 2V.

# Appendix C - Options

## Introduction

This section contains a list and descriptions of available factory installed options at the time of this printing. The list of options contains an option code number which can be referenced on the model option label on the rear panel of the unit when options are present.

## Model Option Label

On the rear panel of the instrument, you will find a label that contains the option code.

For example, your options code will appear as follows:

fitted with option 01 OPT: 01

fitted with option 01 and 02 OPT: 0102

## Hypot Options

CODE	DESCRIPTION
04	3mA AC/DC Output
05	5mA AC/DC Output
06	5Ω Continuity
15	PLC Ready Output
16	7 Remote Memory Remote Select
17	RS-232 Communication Interface
18	Advanced Arc Detection

## 16 7 Memory Remote Select

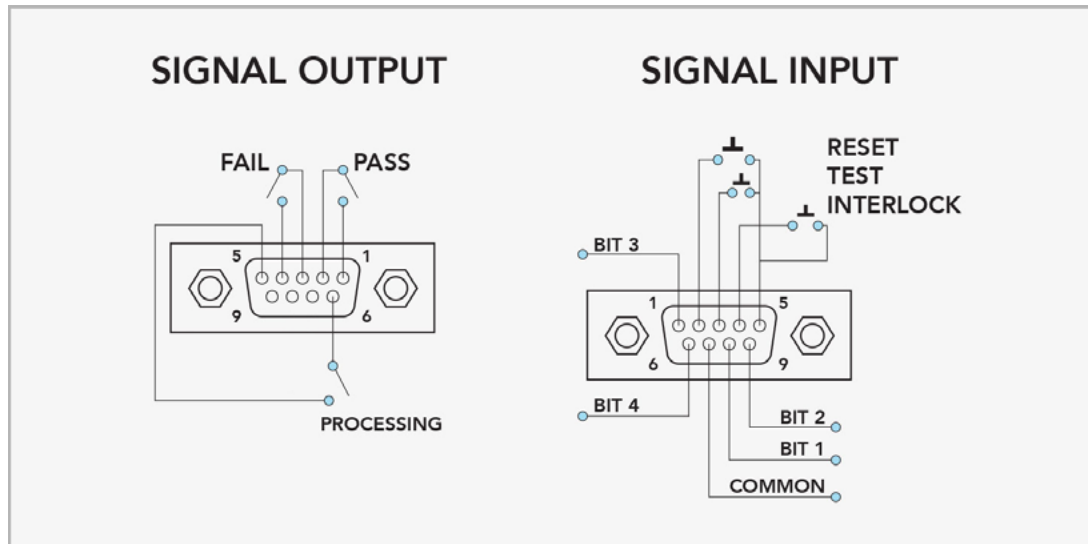



## Remote Signal Inputs and Memory Access

- The Remote File Select function gives you the capability to quickly select and initiate a test remotely.
- You can access first three (3) pre-programmed test files by connecting pins 1, 8 and 9 to the common pin 7, in different combinations. (7 memories available with added option)
- The memory select bits should be set simultaneously and remain set for a minimum of 20ms to guarantee that the correct memory will be selected.
- The memory select bits may be set in sequential manner, provided that the time delay between each bit is less than 4ms.
- When the desired bit pattern has been established it should remain set for a minimum of 20ms to guarantee that the correct memory will be selected.
- It may be necessary to "OR" the momentary switches (relay contacts) to prevent incorrect program selection due to timing errors.

### DID YOU KNOW...

The Remote Signal Input connector may be used with various accessories, including light curtains, foot switches, and safety probes. Contact Associated Research for more information.

REMOTE FILE SELECT TRUTH TABLE

BIT 3	BIT 2	BIT 1	FILE #
0	0	1	01
0	1	0	02
0	1	1	03
1	0	0	04
1	0	1	05
1	1	0	06
1	1	1	07
1= Momentary Contact closure between BIT and COMMON			
0= No Contact closure between BIT and COMMON			

### WARNING

Activating memory program functions through the remote connector, selects the program and starts the test which is preprogrammed into that memory

Activation des fonctions de mémoire programme via le connecteur remote , sélectionne le programme et lance le test qui est préprogrammé dans cette mémoire.

### CAUTION

Do not connect voltage or current to the signal inputs, this could result in damage to the control circuitry.

Ne pas connecter tension ou de courant aux entrées de signal, cela pourrait provoquer des dommages au circuit de contrôle.

## 06 5Ω Continuity

The 5Ω Continuity option increases the Ground Continuity maximum limit from 1.5Ω to 5Ω and increases the Ground Continuity offset range from 0.0Ω – 0.50Ω to 0.0Ω – 0.50Ω. The following specifications have been changed for this option.

<b>Output Current, DC</b>	0.1A ± 0.01A, fixed		
<b>HI-Limit, resistance, Ω</b>	0.00 - 5.00	0.01	
<b>LO-Limit, resistance, Ω</b>	0.00 - 5.00	0.01	
<b>Offset resistance, Ω</b>	0.00 - 1.00	0.01	± (3% of setting + 0.02 Ω)

## 04 3mA AC/DC Output

The 3 mA AC Output option limits the AC Dielectric Withstand Mode output current with software control. The trip points are adjusted to a maximum of 3 mA and the software has been modified so the high-speed maximum current shutdown is fixed at 3 mA. The following table shows the specifications for this option:

3mA AC / DC Output				
AC WITHSTAND VOLTAGE				
SETTINGS				
<b>HI and LO-Limit Current, mA</b>	0.000-3.000	0.001	± (2% of setting + 6 counts)	
MEASUREMENT				
<b>HI and LO-Limit (Total), Current, mA</b>	0.000-4.000 RMS	0.001	± (2% of setting + 2 counts)	
	<b>3.50-5.00 mA RMS</b>	0.01		
<b>Short Circuit Protection</b>	Minimum current 3.5mA RMS at short circuit, Response time < 2ms			
DC WITHSTAND VOLTAGE				
SETTINGS				
<b>Current, uA</b>	<b>HI-Limit</b>	0 - 3000	1	± (2% of setting + 2 counts)
	<b>LO-Limit</b>	0 - 999.9	0.1	
<b>DC Current, μA</b>	0.0 – 400.0 DC		0.1	± (2% of setting + 10 counts) (0.000 - 565.7 Peak) Low Range is ON
<b>DC Current, mA</b>	0.350 – 4.000 DC		0.001	± (2% of setting + 2 counts)
	3.50 - 5.00 RMS		0.01	
<b>Short Circuit Protection</b>	Minimum current 5.8mA DC at short circuit, Response time < 2ms			

## 17 RS-232 Communication Interface

Adds the optional RS-232 interface card on the rear panel.

## 15 PLC Ready Output

The PLC Ready Output option creates a signal that acts as an instrument power-on indicator. The signal is available through the Remote I/O output connector which is located on the back of the instrument. This option closes the relay contact between pin (1) and pin (2) on the output connector once the instrument is powered on. The PLC Ready Output signal replaces the Pass signal that is present on the standard instrument.

It should be noted that the term “Ready” in “PLC Ready Output” only implies that the instrument is powered on. To perform a test, it should be verified that an interlock device is used or the interlock disable connector that was provided with the instrument is installed, and that there are no failure indicators active on the instrument. For more information on the Remote I/O signals/connections and Remote Interlock refer to section Using Remote I/O and PLC Control.

## 05 5mA AC/DC Output

The 5mA Output option limits the output current with software control. The trip points are adjusted to a maximum of 5mA and the software has been modified so the high-speed maximum current shutdown is fixed at 5mA. The following table shows the specifications for this option:

5mA AC / DC Output			
AC WITHSTAND VOLTAGE			
SETTINGS			
HI and LO-Limit, current, mA	0.000-5.000	0.001	± (2% of setting + 2 counts)
MEASUREMENT			
HI and LO-Limit (Total), current, mA	0.000-4.000 RMS	0.001	± (2% of setting + 2 counts)
	3.50 - 5.00 mA RMS	0.01	
Short Circuit Protection	Minimum current 5.8mA RMS at short circuit, Response time < 2ms		
DC WITHSTAND VOLTAGE			
SETTINGS			
HI and LO-Limit, current, uA	0 - 5000	1	± (2% of setting + 2 counts)
	0 - 999.9	0.1	
MEASUREMENT			
DC Current, uA	0.0 - 400.0 DC	0.1	± (2% of setting + 2 counts)
DC Current, mA	0.350 – 4.000 DC	0.001	
	3.50 - 5.00 RMS	0.01	
Short Circuit Protection	Minimum current 5.8mA DC at short circuit, Response time < 2ms		
RS-232 Interface	Adds the the RS-232 communication interface along with the standard USB interface.		
Advanced ARC Detection	Adds the 10-30kHz and 10-150kHz frequency selection for the ARC Detection function. It is user selectable in the menu. If the instrument does not have this option enabled, the default frequency range value is 10-30kHz, non-selectable.		

## 18 Advanced ARC Detection

This option adds a frequency selection of 10-30kHz and 10-150kHz for the Arc Detection function. It is user selectable in the menu.

# Appendix D - Remote BUS Interface: USB

This section provides information on the proper use and configuration of the bus remote interface. The USB remote interface is standard on the Hypot.

The USB interface requires you to download a driver in order for the instrument to recognize the USB interface. The driver can be found on the Associated Research website:

<http://www.arisafety.com/products/software/USB-driver.aspx>

Click on "USB/RS-232 Driver" to download the driver. This link contains an automatic extract and install program. Follow the instructions of the installation program to initialize the driver install. NOTE: The USB port acts as a USB to RS-232 converter. As a result, the PC will recognize the USB port as a virtual COM port.

## USB Interface

This interface provides all of the control commands and parameter setting commands of the GPIB interface with the exception of some of the 488.2 Common Commands and SRQ capability. All commands can be found in USB Command List. The identification command \*IDN and the Status Reporting commands are also available through USB.

### Communications Port Configuration

The COM port should have the following configuration:

- 38400 baud
- 8 data bits
- 1 stop bit
- No parity

This interface does not support XON/XOFF protocol or any hardware handshaking.

### Disconnect USB Communication Icon

Once the USB communication to the instrument is established the front panel touch screen operations will be restricted and a new icon will appear on the bottom right of the screen. To regain access to the front panel touch screen, first stop any active communication from a PC and next touch the Disconnect RS-232 icon. This icon will reappear if there is an active communication via the USB port.

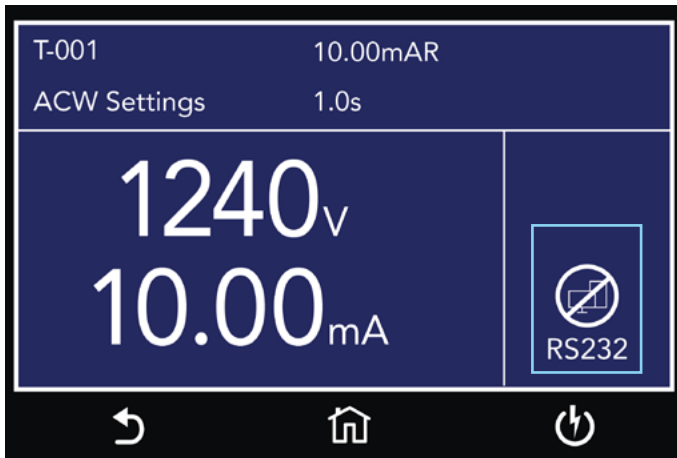

## Sending and Receiving Commands

### Sending Data

Once a command is sent to the instrument over the USB bus the instrument will send one of two responses. If the transfer was recognized and completed the instrument will return with 06 hex or 6 decimal, the Acknowledge (ACK) ASCII control code. If there is an error with the command string that is sent, the instrument will respond with 15 hex or 21 decimal, the Not Acknowledge (NAK) ASCII control code. The ACK or NAK response allows for software handshaking to monitor and control data flow.

### Receiving Data

When requesting data from the instrument it will automatically send the data back to the controller input buffer. The controller input buffer will accumulate data being sent from the instrument, including the ACK and NAK response strings, until it has been read by the controller.

## USB Interface Command List

### USB Responses

The USB bus will automatically send any response back to the controller's input buffer.

### Rules for Sending Commands to the Instrument

The following conventions are used to describe the commands syntax for Hypot:

- Braces ( { } ) enclose each parameter for a command string.
- Triangle brackets ( < > ) indicate that you must substitute a value for the enclosed parameter.
- The Pipe ( | ) is used to separate different parameter options for a command.
- The command and the parameter data must be separated with a space.
- Each command string should be terminated by the ASCII control code, New Line (NL), (OAh) or the end of line (EOL) message for GPIB.
- All commands that end with a question mark ( ? ) are query commands and required an IEEE-488 read command to retrieve the data from the device's output buffer.

## Test Execution Commands

The following commands are used to control actual output voltage and current from the instrument. Please observe all safety precautions.

COMMAND	DESCRIPTION
TEST	Execute a Test
RESET	Abort a test in Process or Reset Failures
SACO	Set Auto Offset Continuity
SACG	Set Auto-Charge-LO

### TEST

Starts the test sequence at the selected step loaded into memory (RAM).

### RESET

Stop or abort a test. Also used to reset a latched failure condition.

### SACO

Set the offset for the Continuity. The cables and any test fixture should be connected before executing the command. This command will perform an actual test and all safety precautions should be observed when using this command.

### SACG

Set the Charge-LO parameter for the DCW or IR test. The cables and any test fixture should be connected before executing the command. The test parameters that are set for the step will be used when performing the auto setting. This command will perform an actual test and all safety precautions should be observed when using this command.

## File Editing Commands

The following commands are used to create or modify Test Setup Files.

- Commands should be separated from parameters by a space.
- If multiple parameters are entered, they should be separated by commas.

COMMAND	DESCRIPTION	VALUE
FL <memory number>	File Load	memory number = 001-2000
FL?	Query FILE Number	
FN nn,xxxx	File Name	nn=01-2000, xxxx=name (Maximum 8 characters)
FR xxx	File Name	xxxx=name (Maximum 8 characters)
FD	File Delete	Current file in use
FD nn	File Delete nn	nn=1-2000
FS	File Save	Current file in use
FSA nn,xxxx	File Save As	nn=1-2000, xx=Name
FT?	File Total	
ST?	Step Total	
SS <step number>	Step Select step number	step number = 1-2000
SS?	Step Select ?	
SAA	Step Add ACW test	
SAD	Step Add DCW test	
SAI	Step Add IR test	
ADD <n,p1,p2,p3...>	Add all parameters of a test step	n=test type, p=parameters
SD	Step Delete current	
SD nn	Step Delete nn	nn=01-2000
SP <prompt mes-sage>	Step Prompt Create	Prompt message = Valid ASCII (1) Maximum 32 characters
SP	Step Prompt Delete	
LP?	List Prompt	
LP nn	List Prompt current	nn=01-2000

(1) "Valid ASCII" is the character set that is available from the front panel LCD user interface. Consisting of upper case alphabet (A-Z), numbers (0-9) and decimal point (.), asterisk (\*), dash (-), under bar ( ), tilde (~) and space (SP).

### **FL <memory number>**

Load a file by memory number from non-volatile memory into random access memory RAM.

### **FN < file name>**

Creates a new file name for the active memory loaded into RAM.

### **SS <step number>**

Selects the active selected step to load into RAM. The step must first be selected before any specific parameters can be edited.

### **SAA, SAD, SAI**

These commands add the appropriate test type within the memory at the step location that has been selected. The parameters of the previous test type will be deleted and the default values for the new test type will be recalled. If the same test type is selected that already exists, the default values will replace the previous parameters.

### **ADD <n, p1,p2,p3...>**

This command adds a step with all parameters to the current file. See the command summary tables below to see the specific test type for each of these commands

The parameter <n> indicates the test type. The values ACW, DCW, or IR must be used. The parameters <p1,p2> etc. indicate the individual settings for each parameter of the test. All parameters must be included with the command and should appear in the same order that is shown in the table below. Also, like the individual parameter editing commands, the unit should not be included with the value; only the numeric value should be included in the command string. When the scanners are being used they should be appended to the end of the string, with the internal scanner first if installed, followed by the external scanner if connected to the rear panel scanner control port.

The list of parameters can also be found in the default parameters section of the manual, or refer to Test Parameter Editing Commands and Companion Queries for the proper values.

The parameter values for file editing commands should use complete text (i.e. "ON" and "OFF" or "Real" and "Total") and not use the coded values that are associated with the test parameter setting commands discussed in Test Parameter Editing Commands and Companion Queries. The LS? companion command will also list all parameters in complete text in the order as they appear in the following table, preceded by the step number. The following table shows examples of the ADD and LS commands:

#### **ADD all parameters for one STEP**

ADD ACW, Voltage(V), HI-Limit(mA), LO-Limit(mA), Ramp Up(s), Dwell Time(s), Ramp Down(s), Arc Sence, Arc Detect, Frequency, Continuity, Cont. HI-Limit( $\Omega$ ), Cont. LO-Limit( $\Omega$ ), Cont. Offset( $\Omega$ )

ADD DCW, Voltage(V), HI-Limit(uA), LO-Limit(uA), Ramp Up(s), Dwell Time(s), Ramp Down(s), Charge-Lo(uA), Arc Sence, Ramp-HI(uA), Arc Detect, Continuity, Cont. HI-Limit( $\Omega$ ), Cont. LO-Limit( $\Omega$ ), Cont. Offset( $\Omega$ )

ADD IR, Voltage(V), HI-Limit(M $\Omega$ ), LO-Limit(M $\Omega$ ), Ramp Up(s), Delay Time(s), Dwell Time(s), Ramp Down(s), Charge-Lo(uA)



## LS? & LS nn? Response Data format

Step, ACW, Voltage(V), HI-Limit(mA), LO-Limit(mA), Ramp Up(s), Dwell Time(s), Ramp Down(s), Arc Sense, Arc Detect, Frequency, Continuity, Cont. HI-Limit( $\Omega$ ), Cont. LO-Limit( $\Omega$ ), Cont. Offset( $\Omega$ )

Step, DCW, Voltage(V), HI-Limit(uA), LO-Limit(uA), Ramp Up(s), Dwell Time(s), Ramp Down(s), Charge-Lo(uA), Arc Sense, Ramp-HI(uA), Arc Detect, Continuity, Cont. HI-Limit( $\Omega$ ), Cont. LO-Limit( $\Omega$ ), Cont. Offset( $\Omega$ )

Step, IR, Voltage(V), HI-Limit(M $\Omega$ ), LO-Limit(M $\Omega$ ), Ramp Up(s), Delay Time(s), Dwell Time(s), Ramp Down(s), Charge-Lo(uA)

	ACW	DCW	IR
1	Step	Step	Step
2	Test	Test	Test
3	Voltage	Voltage	Voltage
4	Hi-Limit	Hi-Limit	Hi-Limit
5	Lo-Limit	Lo-Limit	Lo-Limit
6	Ramp Up	Ramp Up	Ramp Up
7	Dwell Time	Dwell Time	Dwell Time
8	Ramp Down	Ramp Down	Dwell Time
9	Arc Sense	Charge-Lo	Ramp Down
10	Arc Detect	Arc Sense	Charge-Lo
11	Frequency	Ramp-Hi	
12	Continuity	Arc Detect	
13	Cont. Hi-Limit	Continuity	
14	Cont. Lo-Limit	Cont. Hi-Limit	
15	Cont. Off-Set	Cont. Lo-Limit	
16		Cont. Off-Set	

## ADD Command String Examples

Use the following ADD command string to setup a corresponding test with the listed parameters. The command string below can be copied exactly as it appears. The parameters can be edited and sent to the tester via BUS command.

### ACW Test

Test	Voltage (V)	HI-Limit (mA)	LO-Limit (mA)	Ramp Up (s)	Dwell Time (s)	Ramp Down (s)	Arc Sense	Arc Detect	Frequency	Continuity	Cont. HI-Limit ( $\Omega$ )	Cont. LO-Limit ( $\Omega$ )	Cont. Offset ( $\Omega$ )
ACW	1240	0.10	1.01	0.1	1.0	0.0	5	OFF	60	OFF	1.50	0.00	0.00

ADD ACW,1240,0.10,0.010,0.1,1.0,0.0,5,OFF,60,OFF,1.50,0.00,0.00

### DCW Test

Test	Voltage (V)	HI-Limit ( $\mu$ A)	LO-Limit ( $\mu$ A)	Ramp Up (s)	Dwell Time (s)	Ramp Down (s)	Charge LO ( $\mu$ A)	Arc Sense	Ramp Hi ( $\mu$ A)	Arc Detect	Continuity	Cont. HI-Limit ( $\Omega$ )	Cont. LO-Limit ( $\Omega$ )	Cont. Offset ( $\Omega$ )
DCW	1500	7500	0.0	0.4	1.0	0.0	0.0	5	0.0	OFF	OFF	1.50	0.0	0.0

ADD DCW,1500,7500,0.0,0.4,1.0,0.0,0.0,5,0.0,OFF,OFF,1.50,0.00,0.00

### IR Test

Test	Voltage (V)	HI-Limit (M $\Omega$ )	LO-Limit (M $\Omega$ )	Ramp Up (s)	Delay Time (s)	Dwell Time (s)	Ramp Down (s)	Charge-LO ( $\mu$ A)
IR	500	0.00	0.10	0.1	0.5	0.5	0.0	0.000

ADD IR,500,0.00,1.00,0.1,0.5,0.5,0.0,0.000

TYPE	TD? & RD n? Response Data Format
ACW	Step, ACW, Status, Voltage(kV), Current(mA), Time(s)
DCW	Step, DCW, Status, Voltage(kV), Current(uA), Time(s)
IR	Step, IR, Status, Voltage(V), Resistance(MΩ), Time(s)

DISPLAYED MESSAGE	EXAMPLE QUERY RESPONSE					
	STEP	TEST TYPE	STATUS	METER 1 (VOLTAGE)	METER 2 (LEAKAGE CURRENT)	METER 3 (TIMER)
Dwell	1	ACW	Dwell	0.30kV	0.296mA	0.5s
Dwell	2	DCW	Dwell	1.00kV		
Dwell	3	IR	Dwell	0.50kV		

DISPLAYED MESSAGE	EXAMPLE QUERY RESPONSE
Pass	1, ACW, PASS, 0.30, 0.296, 0.5
HI-LMT	2, ACW, HI-LMT, 0.30, 0.192, 0.2
LO-LMT	3, ACW, LO-LMT, 0.15, 0.090, 0.1
OTP	4, ACW, OTP, 0.10, 0.122, 10.0
CONT-F	1, ACW, CONT-F, 0.30, 0.291, 0.4
Dwell	2, ACW, Dwell, 0.30, 0.296, 0.2
Abort	3, ACW, Abort, 0.30, 0.296, 0.2
Ramp	4, ACW, Ramp, 0.30, 0.296, 0.2
Output Error	1, ACW, OUT-ERROR, ---, ---, 0.0
Delay	1, ACW, Delay, 1.97, 0.613, 1.2

**SP <prompt message>**

Adds or edits a prompt message for the active step.

**SP**

Removes or deletes the prompt that had been created for the active step.

**Test Parameter Editing Commands and Companion Queries**

These commands are used to modify the test parameter within each step. These commands require a parameter value to be included with the command. The companion query command will read the parameter. The writing of the parameter requires that the unit not be included with the value, only the numeric value should be included with the command. Also, when the query commands are used the response will not include the unit's characters. Many of the commands will function the same way for multiple test types; however, the input range may be different and therefore used a different possible set of values.

COMMAND	NAME	TEST TYPES	VALUE
EV <value> EV?	Edit Voltage	ACW DCW IR	0 - 5000V 0 - 6000V 30 - 1000V
ECG < value > ECG?	Edit Charge-Lo	DCW IR	0.0 - 350.0uA 0.000 - 3.500uA
ECT {1 0} ECT?	Edit Continuity	ACW DCW	1= On, 0=Off
ECH ECH?	Edit Continuity Hi-Limit		0.00 - 1.50Ω
ECL ECL?	Edit Continuity Lo-Limit		0.00 - 1.50Ω
ECO n	Edit Continuity Offset		0.00 - 0.50Ω
ERU < value> ERU?	Edit Ramp-Up	ACW DCW IR	0.1 - 999.9s 0.1 - 999.9s 0.1 - 999.9s
ERD <value > ERD?	Edit Ramp-Down	ACW DCW IR	0.0 - 999.9s 0, 1.0 - 999.9s 0, 1.0 - 999.9s
ERH n ERH?	Edit Ramp-Hi n	DCW	n=0-7500uA
EDW < value > EDW?	Edit Dwell	ACW DCW IR	0, 0.2 - 999.9s 0, 0.4 - 999.9s 0, 0.3 - 999.9s
EDE < value > EDE?	Edit Delay	IR	0.5 – 999.9s
ECO < value > ECO?	Edit Offset	CONT	0.0 - 0.5Ω
EA < value > EA?	Edit Arc	ACW DCW	1 - 9
EAD {1 0} EAD?	Edit Arc-Detect	ACW DCW	1= On, 0=Off

Continued on next page →

EH < value > EH?	Edit HI-Limit	ACW DCW IR	0.0- 20.00mA 0.0 - 7500uA 0 - 50000MΩ
EL < value > EL?	Edit Min-Lmt / LO-Limit	ACW DCW IR	0.000 - 9.999mA 0.0 - 20000uA 0.1 - 50000MΩ
EF n EF?	Edit Frequency	ACW	n=0-3, 0=50Hz, 1=60Hz

### System Parameter Editing Commands and Companion Queries

These commands are used to modify the system parameters for the instrument. These commands require a parameter value to be included with the command. The companion query command will read the parameter using the same value that is used for setting the parameter.

COMMAND	NAME	VALUE
SPR {1 0} SPR?	PLC Remote	1= On, 0=Off
SSI {1 0} SSI?	Single Step	1= On, 0=Off
SF {1 0} SF?	Fail Stop	1= On, 0=Off
SDM n SDM?	Edit Diagnostic Memory	1= On, 2= Off
SAL < value > SAL?	Alarm Volume	0-9
SL {1 0} SL?	Lock	1= On, 0=Off
SSG n SSG?	Smart GFI	n=0 1= On, 2= Off
SR {2 1 0} SR?	Results	0=ALL, 1=P/F, 2=LAST
SCA {1 0} SCA?	Cal Alert	1= On, 0=Off
SCDA < value > SCDA?	Cal Date	mm,dd,yy or yy,mm,dd or dd,mm,yy according to SDF setting
SCDU < value > SCDU?	Cal Due	mm,dd,yy or yy,mm,dd or dd,mm,yy according to SDF setting
SA < value > SA?	Alert Date	mm,dd,yy or yy,mm,dd or dd,mm,yy according to SDF setting
SDT < value > SDT?	System Date	mm,dd,yy or yy,mm,dd or dd,mm,yy according to SDF setting
SDF < value > SDF?	Date Format	0=yy,mm,dd, 1=mm,dd,yy, 2=dd,mm,yy
STM < value > STM?	Time	hh,mm (24hr) hh,mm,AM or hh,mm,PM (12hr) according to STF setting
STF {1 0} STF?	Time Format	0=12hr, 1=24hr

Continued on next page →

COMMAND	NAME	VALUE
SIS	Import System	
SIF xxxxxxxx	Import File	xxx=name
SRF?	Read USB.H4 File	
SIAF xxxxxxxx	Import All Files	xxx=name
SIAD xxxxxxxx	Import All Data	xxx=name
SES xxxxxxxx	Export System	xxx=name
SEF xxxxxxxx	Export File	xxx=name
SMM n SMM?	Home Screen	n=0-2, 0=Perform Tests, 1=Menu, 2=My Menu
SAN n SAN?	Animation	n=0-1 0=Continue, 1=Pause
SLA n SLA?	Language	n=0-7, 0=English, 1=Traditional Chinese 2=Simplified Chinese,3=Spanish 4=Portuguese, 5=Turkish 6=German, 7=French
SCS n SCS?	Color Style	n=0-2 0=White, 1=Black, 2=Blue
SH3 n SH3?	Edit H3 Mode	1= On, 2= Off
STS n STS?	Touch Sound	n=0-1 0=Off, 1=On
SDUT n SDUT?	Dual Test	n=0-1 0=Off, 1=On
SRS n SRS?	Result Save	n=0-1 0=Internal memory, 1=USB Disk
STR n STR?	Test Results	n=0-3 0=None, 1=Fail, 2=Pass, 3=All
SRL n SRL?	Results Limit	n=0-1500
STL n STL?	Time Limit	n=0-99
SRN xxxxxxxx SRN?	Results Name	xxx=name
SUL n?	User	n=0-299 Name, Password, Level
SUA p,p,p,p	User Add	SUA Pointer,Name,Password,Level Pointer: 1-5 Name: 8 character max Password: 8 number max Level: 0=Run Only, 1=Recall Setup, 2=Edit Step, 3=Full System

Continued on next page →

COMMAND	NAME	VALUE
SUD n	User Delete	n=1-5
SUE p,p,p,p	User Edit	SUA Pointer,Name,Password,Level Pointer: 1-5 Name: 8 character max Password: 8 number max Level: 0=Run Only, 1=Recall Setup, 2=Edit Step, 3=Full System
SBI n SBI?	Barcode IP Format	n=0-4 0=Off, 1=Ser/Prod, 2=Serial#, 3=Product#, 4=Run File
SAS n SAS?	Auto Start Format	n=0-1 0=Off, 1=On

## Query Commands

These query commands will retrieve data from the instrument. These commands include functions for retrieving test data, test results and remote hardware status, as well as setup file information.

COMMAND	NAME	VALUE
TD?	List Testing Data	Test In Process
RDM?	Read Max Current	ACW: Total current, Real Current DCW: current
RD <step number>?	List Results Data	step number = 1-200
RR?	Read Remote Reset	1=Open, 0=Closed
RI?	Read Remote Interlock	1=Open, 0=Closed
RU?	Read USB Stick	0=NO, 1=YES
LF?	List File Name	Active selected memory
LF nn?	List File Name	Active selected file
LP?	List Prompt	Active selected Step
LP <step number>?	List Prompt by step number	Step number = 1-50
LS?	List Step Parameters	
LS <step number>?	List Step Parameters by step number	Step number = 1-50

### TD?

Read the active data being displayed on the LCD display while the test is in process. Also read the last data taken when the test sequence has completed. Each parameter is separated by commas and includes step number, test type, test status, and metering. The syntax for this command response is {step, test type, status, meter 1, meter 2, meter 3}. ACW test displays 3 meters. Each meter will contain only the value and not the units. In the case of DCW current where both uA and mA are used on the display, the command response will always indicate the current in uA for example 2.0mA will respond with 2000 for 2000uA.

### RD <step number>?

Read the results for an individual step. The step number is the actual step number that has been saved within the file, not the order of which the steps were executed. For example if the test was executed starting from step 3 and ending with step 5 then the first step test results will be found in location 3 not in location 1. Each parameter is separated by commas and includes step number, test type, test status, and metering. The syntax for this command response is {step, test type, status, meter 1, meter 2, meter 3}. ACW test displays 3 meters. Each meter will contain only the value and not the units. In the case of DCW current where both uA and mA are used on the display the command response will always indicate the current in uA for example 2.0mA will respond with 2000 for 2000uA.

### RR?

Read the remote Reset input signal. When the remote reset has been activated by closing the contacts the query will return a value of 1 to indicate the instrument is being Reset.

### RI?

Read the remote Interlock input signal. When the remote Interlock has been activated by opening the contacts the query will return a value of 0 to indicate the instrument is in the Interlock state and will not be able to generate output voltage or current.

### LF?

Lists the file name of the memory loaded into active memory (RAM).



**LFN?**

Lists the memory number of the active memory file loaded into active memory (RAM).

**LF <memory number>?**

List the file name of any of the 50 memories.

**LP?**

Lists the prompt that is created for the selected step within active memory (RAM).

**LP <step number>?**

Lists the prompt that has been created for a particular step of the file within active memory (RAM).

**LS?**

Lists all the parameters for the individual step that is currently selected. See the ADD command for the list of parameters. A comma (,) will separate each parameter and will be preceded with the step number.

**LS <step number>?**

Lists all the parameters for the individual step indicated by step number = 1-30. See the ADD command for the list of parameters. A comma (,) will separate each parameter and will be preceded with the step number.

**IEEE 488.2 Common Commands**

These commands are required by the IEEE-488.2 standard with the exception of \*PSC, \*PSC?. Most of these commands are not available over the USB/RS-232 bus except for the \*IDN? command which can be used to retrieve the instrument identification information, and the four status reporting commands \*ESR?, \*ESE, \*ESE? and \*STB?

COMMAND	NAME	VALUE
*IDN?	Identification Query	Associated Research Inc., Model Number, Serial Number, Firmware Revision
*RST	Reset Command	Resets HYPOT
*TST?	Self-Test Query	00H=OK 01H=TEST EEPROM ERROR
*CLS	Clear Status Command	Clear Standard Event Status Register Clear Service Request Register
*OPC	Operation Complete Command	When all selected pending operations complete, ESR BIT0=1
*OPC?	Operation Complete Query	When all selected pending operations complete, Output Queue=1
*WAI	Wait-to-Continue Command	
*PSC {1 0}	Power-on Status Clear Command	1 = Power-on clear enable registers 0 = Power-on load previous enable registers
*PSC?	Power-on Status Clear Query	
*ESR?	Standard Event Status Register Query	0 - 255
*ESE <value>	Standard Event Status Enable Command	Value = 0 - 255
*ESE?	Standard Event Status Enable Query	0 - 255
*STB?	Read Status Byte Query	Read Status Byte
*SRE <value>	Service Request Enable Command	Value = 0 - 255
*SRE?	Service Request Enable Query	0 - 255

**\*IDN?**

Read the instrument identification string. Company = Associated Research Inc.

**\*RST**

Reset the instrument to original power on configuration. Does not clear Enable register for Standard Summary Status or Standard Event Registers. Does not clear the output queue. Does not clear the power-on-status-clear flag.

**\*TST?**

Performs a self-test of the instrument data memory. Returns 0 if it is successful or 1 if the test fails.

**\*CLS**

Clears the Status Byte Summary register and Event registers. Does not clear the Enable registers.

**\*OPC**

Sets the operation complete bit (bit 0) in the Standard Event register after a command is completed successfully.

**\*OPC?**

Returns an ASCII "1" after the command is executed.

**\*WAI**

After the command is executed, it prevents the instrument from executing any further query or commands until the no-operation-pending flag is TRUE.

**\*PSC {1|0}**

Sets the power-on status clear bit. When set to 1 the Standard Event Enable register and Status Byte Enable registers will be cleared when power is turned ON. 0 setting indicates the Enable registers will be loaded with Enable register masks from non-volatile memory at power ON.

**\*PSC?**

Queries the power-on status clear setting. Returns 0 or 1.

**\*ESR?**

Queries the Standard Event register. Returns the decimal value of the binary-weighted sum of bits.

**\*ESE <value>**

Standard Event Enable register controls which bits will be logically OR'd together to generate the Event Summary bit 5 (ESB) within the Status Byte.

**\*ESE?**

Queries the Standard Event enable register. Returns the decimal value of the binary-weighted sum of bits.

**\*STB?**

Read the Status Byte. Returns the decimal value of the binary-weighted sum of bits.

**\*SRE <value>**

Service Request Enable register controls which bits from the Status Byte should be used to generate a service request when the bit value = 1.

**\*SRE?**

Queries the Service Request enable register. Returns the decimal value of binary-weighted sum of bits.

## Status Reporting

The status reporting system is configured using two types of registers. An Event register and a Summary register. The Summary register is known as the Status Byte register and records high-level summary information acquired by the Event registers.

An Event register report defines conditions or messages at each bit. The bits are latched and remain at an active state until the register is either Read or Cleared. Reading the Event register automatically clears the register and sets all bits to inactive state or 0. When querying an Event register the information is returned as a decimal number representing the binary-weighted sum of all bits within the register.

The Enable registers bits represent the selection of bits that will be logically OR'd together to form the summary bit in the Status Byte. The \*CLS command will not clear the Enable registers and if you wish to clear the register you must set it to a value of 0. Like the Event register, the enable register is represented as a decimal number that equals the binary-weighted sum of all bits.

The Enable register will clear to value a of 0 at power up unless the \*PSC 0 command had been executed before power-off. The \*PSC command tells the device whether or not it should clear the Enable registers at power-on. Using this command will allow SQRs to function immediately after power-on.

Bit	Binary Weight
0	1
1	2
2	4
3	8
4	16
5	32
6	64
7	128

EVENT REGISTER	
Event Register	Enable Register
Operation Complete	
not used	
Query Error	
Device Error	
Execution Error	
Command Error	
not used	
Power On	

\*ESR?

\*ESE  
\*ESE?

EVESTATUS BYTE REGISTER	
Summary Register	Enable Register
ALL PASS	
FAIL	
ABORT	
TEST IN PROCESS	
Message Available (MAV)	
Event Summary Bit (ESB)	
Request Service (RQS) or Master Summary Status (MSS)	not used
PROMPT	

\*STB? | SPOLL

\*SRE  
\*SRE?

# Appendix E - Replacement Parts List

PART NUMBER	QTY.	REF. DESIGNATOR	DESCRIPTION
<b>Supplied Accessories</b>			
40032 <sup>2</sup>	2	-	3U Rack Mount Bracket
40031 <sup>2</sup>	2	-	3U Rack Mount Handle
37581 <sup>2</sup>	4	-	Screw for Rack Mount Handle
378801	1	-	3.15 Amp, fast acting 250VAC
384302	1	-	115Vac, 230VAC - 15A/250VAC Slow-Blow
04040A-08	1	-	High Voltage Cable
39066	1	-	USB Cable AB-Type 1.8m
33189 <sup>1</sup>	1	-	Cable Input Cordset USA (3805/55/65/70)
38071 <sup>2</sup>	1	-	Cable Input Cordset USA (3880)
38075	1	-	Interlock Connector
36544	1	-	Adapter Box
02100A-13	2	-	Cable Assembly Return
39681	1	-	LCD Protective Film
39571	1	-	8GB White USB Flash Drive
<b>Panel Components</b>			
40048 <sup>2</sup>	1	-	High Voltage Connector Front w/Wire
40049 <sup>2</sup>	1	-	High Voltage Connector Rear w/Wire
40043 <sup>1</sup>	1	-	High Voltage Connector Front w/Wire
40044 <sup>1</sup>	1	-	High Voltage Connector Rear w/Wire
35999	4	-	Black Banana Jacks
37571	1	-	Earth Connector
40004	1	TEST	Test Switch Green Lighted
40005	1	RESET	Reset Switch Red Lighted
40001	1	-	Feet Kit w/o Rubber Inserts
38102	2	-	Rubber Insert for Front Feet
40000	2	-	Rubber Insert for Rear Feet
39572	1	-	Color LCD Touch Screen
38972 <sup>2</sup>	1	-	DC Fan
39575 <sup>2</sup>	1	-	Fan Grill

<sup>1</sup>3805, 3865, 3870 Only

<sup>2</sup>3880 Only

PART NUMBER	QTY.	REF. DESIGNATOR	DESCRIPTION
<b>PCB Assemblies</b>			
40448 <sup>1</sup>	1	CON 3870	Main Control Board
39965 <sup>2</sup>	1	CON 3880	Main Control Board (3880)
39960	1	HRY 3870	High Voltage Relay Board
39957 <sup>1</sup>	1	AMP 3870	Power Amplifier Board
39964 <sup>2</sup>	1	AMP 3880	Power Amplifier Board (3880)
39958 <sup>1</sup>	1	CNT 3870	Continuity Board
40026 <sup>2</sup>	1	CNT 3880	Continuity Board
39961	1	KEY 3800	Keypad Board
39963	1	USB 3800	USB/Barcode Board
39962	1	LED 3800	High Voltage Indicator
40473	1	RS-232 Card	RS-232 Card (included with Option 17)
38730	1	RS-232 Cable	RS-232 Cable (included with Option 17)
<b>Internal Components</b>			
399801	1	T2	High Voltage Output Transformer
399792	1	T2	500VA Output Transformer (3880)

<sup>1</sup>3805, 3855, 3865, 3870 Only

<sup>2</sup>3880 Only

# Appendix F – Calibration Procedure

## DID YOU KNOW?

This instrument has been fully calibrated at the factory in accordance to our published specifications and with standards traceable to the National Institute of Standards & Technology (NIST).

You will find in this manual a copy of the “Certificate of Calibration”. It is recommended that you have this instrument recertified at least once per year. Associated Research recommends you use “Calibration Standards” that are NIST traceable or traceable to agencies recognized by NIST to keep this instrument within published specifications. Unless necessary, do not recalibrate the instrument within the first 12 months.

End user metrology standards or practices may vary. These metrology standards determine the measurement uncertainty ratio of the calibration standards being used. Calibration adjustments can only be made in the Calibration mode and calibration checks or verifications can only be made while operating in Test mode.

**NOTE:** Verification should be performed before and after calibration. Calibration effects will only be noticeable after exiting calibration mode.

## Warranty Requirements

Associated Research offers a standard three year manufacturer’s warranty. This warranty can be extended an additional five years provided that the instrument is returned each year to Associated Research for its annual recertification. In order to be eligible for the extended warranty instruments must be returned to Associated Research for certification service at least once every twelve months.

A return material authorization number (RMA) must be obtained from Associated Research before returning this instrument for calibration. To obtain an RMA number or for information regarding our warranty, please contact our customer support representatives at 1-800-858-TEST (8378) or setup an RMA online at <http://www.arisafety.com/support/rma-request/>

## Required Calibration Equipment

- 0 - 5 KV AC/DC Metered Voltage Divider.
- 20 mA AC, 10 mA DC Ammeter.
- 1 $\Omega$ , 0.25 watt resistor, 250 volt.
- 50M $\Omega$ , 0.25 watt resistor, 1000 volt.
- 500M $\Omega$ , 0.25 watt resistor, 1000 volt.
- 100K $\Omega$ , 250 watt resistor, 5000 volt.
- 1M $\Omega$ , 20 watt resistor, 5000 volt.

## Calibration Initialization

Press and hold the calibration key on the rear panel with a pen, pencil, or small screwdriver while powering ON the Hypot. The Hypot enters calibration mode after the power on sequence is complete. When the calibration is initialized the calibration screen will display each calibration point and appear as follows:

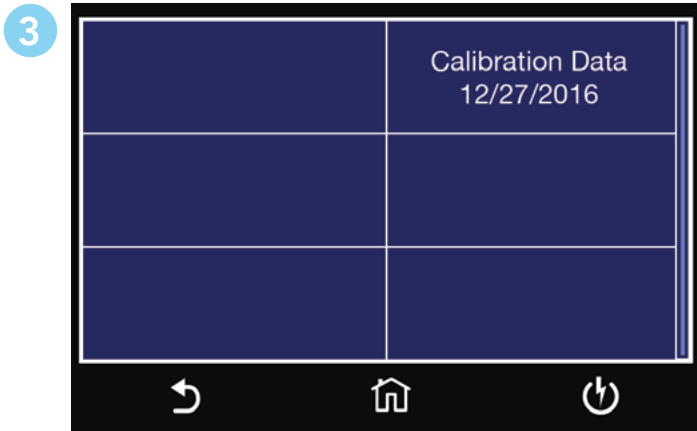

From the Calibration screens, use the touchscreen to select the parameter you wish to calibrate. A calibration prompt screen will now appear that describes the necessary load and connection information for the parameter being calibrated.

Once you press TEST, the Calibration data entry screen will appear for the selected parameter. Read the measurement from your standard and enter it using the numeric keypad. Once a value is entered the screen for the next step will appear.

## Calibration Examples

### Calibration of AC Hipot Voltage

1

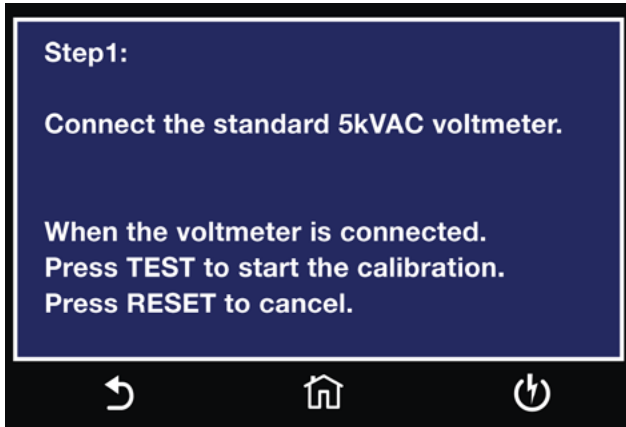

Follow on screen instruction to complete Step 1.

2

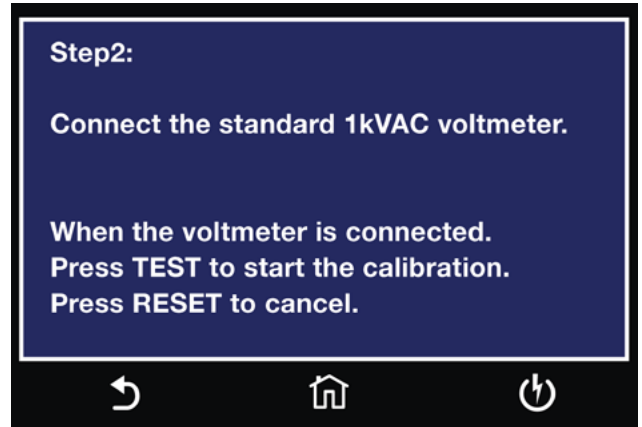

Follow on screen instruction to complete Step 2.

3

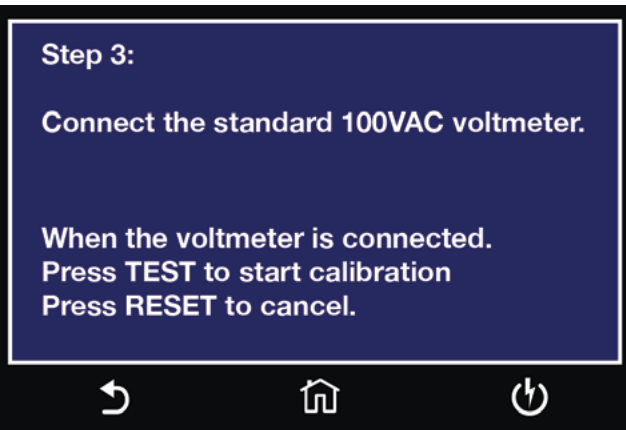

Follow on screen instructions to complete Step 3.



## Calibration of DC Hipot Voltage

1

**Step1:**

Connect the standard 5kVDC voltmeter.

When the voltmeter is connected.  
Press TEST to start the calibration.  
Press RESET to cancel.



Follow on screen instruction to complete Step 1.

2

**Step2:**

Connect the standard 1kVDC voltmeter.

When the voltmeter is connected.  
Press TEST to start the calibration.  
Press RESET to cancel.



Follow on screen instruction to complete Step 2.

3

**Step3:**

Connect the standard 100VDC voltmeter.

When the voltmeter is connected.  
Press TEST to start the calibration.  
Press RESET to cancel.



Follow on screen instruction to complete Step 3.

## Calibration of 20mA AC Current Range

1

Connect the 100 $\Omega$  load in series with  
20mA AC current meter.

When the load and meter are connected.  
Press TEST to start the calibration.  
Press RESET to cancel.



Follow on screen instruction to complete Step 3.

### Calibration of 3.5mA AC Current Range

1

Connect the 100k $\Omega$  load in series with 3.5mA AC current meter.

When the load and meter are connected. Press TEST to start the calibration. Press RESET to cancel.



Follow on screen instruction to complete this step.

### Calibration of 7.50 mA DC Current Range

1

Step 1:

Connect the 100k $\Omega$  load in series with 7.50 mA DC current meter.

When the voltmeter is connected. Press TEST to start the calibration. Press RESET to cancel.



Follow on screen instruction to complete this step.

### Calibration of 3.5uA DC Current Range

1

Connect the 100 $\Omega$  load in series with 35uA DC current meter.

When the load and meter are connected. Press TEST to start the calibration. Press RESET to cancel.



Follow on screen instruction to complete this step.

### Calibration of 3.500mA DC Current Range

1

Connect the 1M $\Omega$  load in series with 350uA DC current meter.

When the load and meter are connected. Press TEST to start the calibration. Press RESET to cancel.



Follow on screen instruction to complete this step.

### Calibration of 35uA DC Current Range

1

Connect the 50M $\Omega$  load in series with 35uA DC current meter.

When the load and meter are connected. Press TEST to start the calibration. Press RESET to cancel.



Follow on screen instruction to complete this step.

### Calibration of 3.5uA DC Current Range

1

Connect the 50M $\Omega$  load in series with 3.5uA DC current meter.

When the load and meter are connected. Press TEST to start calibration. Press RESET to cancel.



Follow on screen instruction to complete this step.

## Calibration of 350nA DC Current Range

1

Connect the 1G $\Omega$  load in series with 350nADC current meter.

When the load and meter are connected.  
Press TEST to start the calibration.  
Press RESET to cancel.



Follow on screen instruction to complete this step.

## Calibration of DC Continuity Offset

1

Short the CONT. Check and Return leads together.

When the leads are shorted.  
Press TEST to start the calibration.  
Press RESET to cancel.



Follow on screen instruction to complete this step.

## Calibration of DC Continuity 1 $\Omega$

1

Connect the standard 1 $\Omega$  load from CONT. to Return.

When the standard load is connected.  
Press TEST to start the calibration.  
Press RESET to cancel.



Follow on screen instruction to complete this step.